

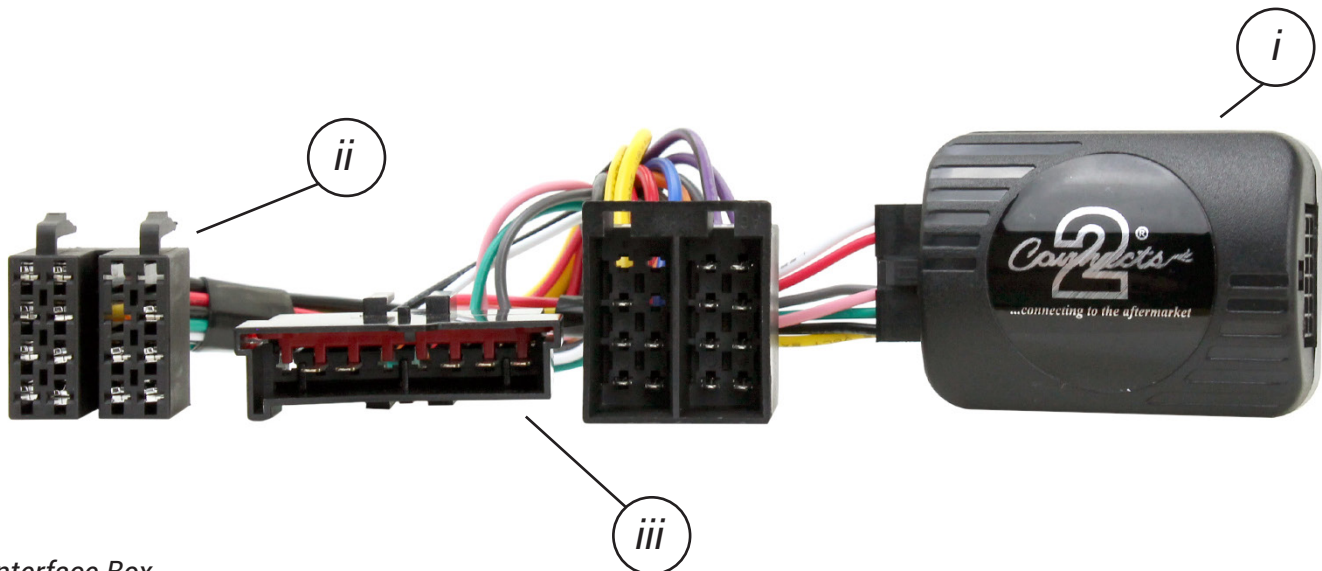

CTSRN002

# Steering Wheel Control Interface for Renault Vehicles



- i. Interface Box
- ii. Male ISO Connector
- iii. Vehicle Specific Connector

Designed and  
Engineered  
in the UK. 

## APPLICATION

*Note: Application data is subject to change at any time*

<b>Renault Clio (II)</b>	<b>1997 - 2000</b>
<b>Renault Kangoo (KC)</b>	<b>1997 - 2000</b>
<b>Renault Laguna</b>	<b>1997 - 2000</b>
<b>Renault Megane (JA)</b>	<b>1997 - 2000</b>
<b>Renault Scenic (I)</b>	<b>1997 - 2000</b>

*For analogue vehicles with Philips 22DC459/579/461 original stereos and 8 way ISO connectors*

## FEATURES

- **Retains Factory Steering Wheel Control Functions** *(if vehicle is equipped)*

### DISCLAIMER

*The information provided in this document is subject to change without notice due to manufacturer changes and/or improvements to the product/s. This instruction manual is based on documented data and research. The manufacturer of this product cannot be held responsible for any changes made to the vehicle by the manufacturer or damages that may occur through the installation of this product in accordance with the steps outlined herein.*

# PRIOR TO INSTALLATION

Read the manual prior to installation. Technical knowledge is necessary for installation. The place of installation must be free of moisture and away from heat sources. Please ensure that the correct tools are using during the installation to avoid damage to the vehicle or product. Connects2 can not be held responsible for the installation of this product.

## WIRING KEY

### IN WIRING HARNESS

Purple	Right Rear Speaker +	Yellow	Permanent 12V
Purple/Black	Right Rear Speaker -	Black	Ground
Green	Left Rear Speaker +	Red	Ignition 12V
Green/Black	Left Rear Speaker -		
Grey	Right Front Speaker +		
Grey/Black	Right Front Speaker -		
White	Left Front Speaker +		
White/Black	Left Front Speaker -		

### ADDITIONAL CONNECTIONS

Not Applicable

## STEERING WHEEL CONTROL FUNCTIONALITY

The following diagram, though based on careful research, is an example only  
Individual steering wheel control configurations may differ.

### FRONT

### REAR

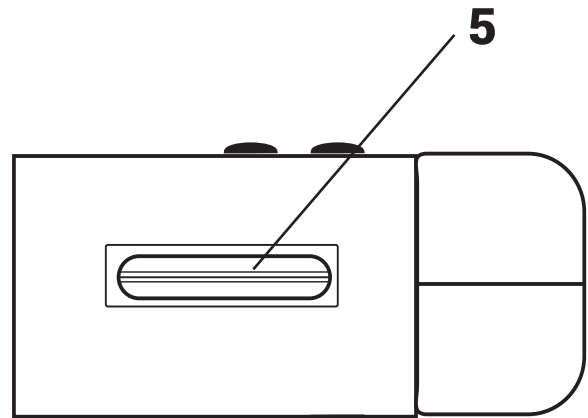
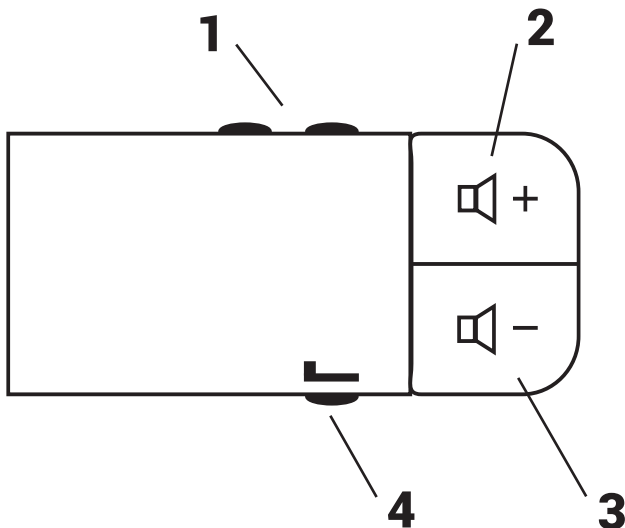

1. Source
2. Volume +
3. Volume -
4. Preset +

5. Track + / - (Scroll Wheel)

Before installing the interface, the factory stereo must be removed and disconnected. To do this, please consult the vehicle owner's manual/handbook or contact a fitting professional.

A stereo connection (patch) lead is also required for the installation of this interface (supplied separately). Please ensure that you have the correct lead before proceeding. For universal patch leads, prepare the wiring loops in accordance with the instruction manual supplied with the product before installation.

1. Connect the 12 Pin connector from the stereo connection (patch) lead to the interface box (i)
2. Connect the opposite end of the stereo connection (patch) lead to the steering wheel control input on the back of the aftermarket stereo

*NOTE: This may be a 3.5mm jack connector or a wired input depending on the brand of aftermarket stereo being fitted. Please consult the aftermarket stereo installation manual for further information on where to make the connection*

**IMPORTANT: THIS STEP MUST BE COMPLETED BEFORE CONNECTING POWER TO THE INTERFACE. FAILURE TO DO SO MAY RESULT IN A LACK OF FUNCTIONALITY AND THE NEED TO REINSTALL THE PRODUCT**

3. Connect the 14 Pin connector from the supplied wiring loom to the interface box (i)
4. Connect the male power/speaker ISO connector to the female power/speaker ISO connector from the aftermarket stereo. (ii)

*NOTE: For aftermarket stereos which do not have an ISO connector, please see "Wiring Key" on Pg.2 for information on which wires to connect. Some interfaces may also have additional 'flying' wires which can be connected to the vehicle to support various features ie. parking brake trigger, reverse gear and speed pulse. Details of these can be found under 'Additional Connections'.*

5. Connect the female vehicle specific connector/s on the supplied harness to the male vehicle specific connector from the vehicle. Please refer to wiring diagram on Pg.4, or cover photo on Pg.1 for more information on the connector style of this interface. Common styles include Mini ISO or Quadlock. (iii)
6. Test stereo and steering wheel control functionality for correct operation before reassembling the vehicle dashboard. If steering wheel control functions are unresponsive, please uninstall the interface and wiring and reinstall carefully in accordance with the above steps.

For further help and support, please contact us directly at [support.connects2.com/tickets/technical](https://support.connects2.com/tickets/technical) and fill out a support ticket with the full details of your issue.

# WIRING DIAGRAM

**TOWARDS VEHICLE**

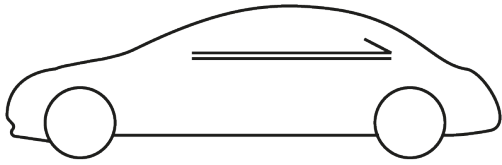

**TOWARDS STEREO**

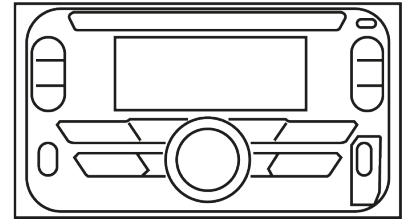

← **Vehicle Specific Connector**  
Connect to vehicle specific connector from vehicle

**Male ISO Connector** →  
Connect to aftermarket stereo

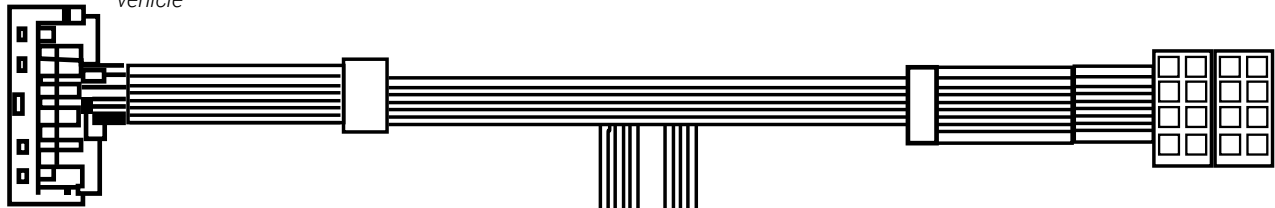

**Main Wiring Loom Connector [14 Pin]**  
Connect to Interface Box

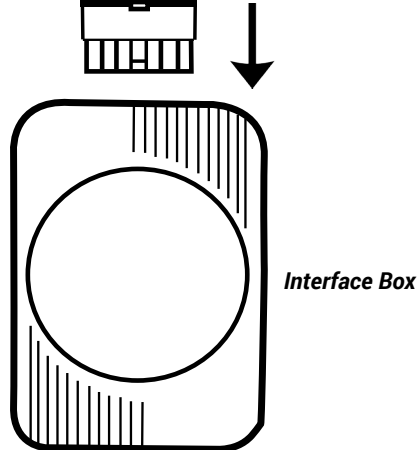

↑ **Stereo Connection (Patch) Lead Connector [12 Pin]**  
Connect to Interface Box

Note: Must be connected first, before power connection is made to the interface