



Z-N528



INFOTAINER
USER MANUAL

EN

Device user manual for ZENEC media system

We are delighted that you have chosen a product from ZENEC.

Please read this operating manual before you start your new ZENEC system. In this device user manual you will find important instructions and information for the safe operation of the ZENEC system, and to help you make the most of its technical advantages.

All the information in this manual corresponds to the state at the time of going to press, and applies only to ZENEC systems in original condition. On account of possible updates to device software, the illustrations and features shown in this operating manual may be different from your ZENEC system. Differences in the information, illustrations or features cannot form a basis for any claims.

If you sell your vehicle with the ZENEC system still fitted, please ensure that this operating manual stays with the vehicle, and that any personal data like a phonebook stored in the device is deleted.

CONTENTS

SAFETY INSTRUCTIONS	04
TURN DEVICE ON AND OFF	05
ANTI-THEFT PROTECTION	05
MULTIFUNCTION STEERING WHEEL CONTROLS	06
Z-N528 (FRONT PANEL)	07
MAIN MENU ICONS	08
MEDIA AUDIO SOURCES	09
INPUT SOURCES	10
STATUS BAR	11
SEARCH AND INPUT FUNCTION	12
UKW (FM) RADIO	13
FM BAR GRAPH MODE	14
MANUAL FM STATION SEARCH	15
UKW SETUP (FM)	16
DAB+ RADIO SETUP	17
DAB+ ENSEMBLE AND STATION LIST	18
DAB+ SETUP	19
DAB+ STATIONS-PRESETS	20
USB / BT A2DP / mSD / IPOD (AUDIO) MEDIA	21
USB / BT A2DP / mSD / IPOD (AUDIO) MEDIA CONTROL AND OPERATION BAR	22
BT-MUSIC (A2DP)	23
IPOD (AUDIO)	24
PLAYLIST (AUDIO)	25
SMART PLAYLIST (AUDIO)	26
FAV PLAYLIST (AUDIO)	27
VIDEO MEDIA: HARDDISK	28
PLAYLIST (VIDEO)	29
HDMI	30
CAMERA	31
CAMERA GRID-LINES: ZENEC TYPE	32
ANDROID AUTO	33-34
APPLE CARPLAY	35
APPLE CARPLAY OPERATION	36

BLUETOOTH (HANDS-FREE SYSTEM)	37
CONTROL AND OPERATION BAR (RIGHT)	38
DEVICE MANAGER	39
PAIRING	40
BLUETOOTH SETUP	41
BLUETOOTH STATUS BAR	41
ACCEPTING/ENDING INCOMING CALLS (VIA DEVICE)	42
OUTGOING CALL VIA NUMERIC PAD	42
OUTGOING CALL VIA PHONEBOOK	42
BLUETOOTH MENU	43
PHONEBOOK	44
CALL LISTS	45
FAVORITES	46
SETUP OPERATIONS	47
DISPLAY ICON (BRIGHTNESS)	48
SETUP OF SOURCES	49
MISC SETUP	50
AUDIO SETUP	51
VOLUME SETUP	52
QUICK AUDIO SETUP (BAL/FAD/SUBWOOFER/LOUDNESS/BASS BOOST)	53
AUDIO SETUP: EXPERT MODE	54
AUDIO VOLUME – BASE LEVEL SETUP	55
BALANCE / FADER	56
EQUALIZER	57
X-OVER SETUP	58
SUBWOOFER SETUP	59
TIME ALIGNMENT	60
TFT DISPLAY CONFIGURATIONS	61
CAR (VEHICLE) SETUP	62
INPUT SETUP	63
SYSTEM SETUP	64
SOFTWARE VERSION	65
CLOCK TIME	66
PASSWORD	67
INSTALLATION NOTES	68
REMOVAL WORK AND PREPARATION	68
OVERVIEW ACCESSORIES	69
COMMISSIONING	69
CONNECTION DIAGRAM Z-N528	70-71
ABBREVIATIONS / GENERAL	72
STATUTORY RIGHTS AND WARRANTY	73-74

SAFETY INSTRUCTIONS

CAUTION

If the driver of the vehicle is distracted, this may lead to an accident or injury. Operating the ZENEC system can distract attention from the general traffic situation! Equally, connecting, changing or inserting data media can distract the driver from the general traffic situation.

CAUTION

Always choose loudspeaker settings such that acoustic signals coming from outside can always be heard in the vehicle (e.g. signal horns or sirens).

CAUTION

Incorrect installation or commissioning of the ZENEC system may cause damage to the ZENEC system or to the vehicle electronics. Only let qualified specialists authorized by ZENEC install the device.

CAUTION

This ZENEC system is intended solely for operation at an on-board voltage of 12 V DC. Operating the ZENEC system at any other voltage can cause damage to the ZENEC system or to the vehicle electrical system.

CAUTION

Taking apart or modifying the ZENEC system can result in damage to the device or the vehicle. Opening the device or modification by a person not authorized by ZENEC will render warranty claims null and void.



In the event of a malfunction or defect please contact an authorized ZENEC dealer. Unauthorized repairs will render warranty claims null and void.

CAUTION

The connection and charging leads of external mobile devices can get in the way of the driver. Please run these so that the driver's freedom of movement is not hindered.

TURN ON / OFF

Manual On / Off Z-N528

-  Press the power button (fig. S/7 ), to turn the ZENEC system on, press and hold the power button to switch off the device.

Automatic On / Off

Vehicles without CAN bus:

The device automatically switches on/off by ignition signal.

Vehicles with CAN/Stalk interface:

Switching on the ignition will activate the ZENEC system. The boot process can take up to 1.5 minutes. This may result in some delay until the system is ready. The ZENEC system is shut down by switching off the ignition, or removing the ignition key.

NOTE

Use of the multifunction steering wheel and other vehicle functions will require a vehicle-specific CAN/Stalk interface. Further information may be obtained from an authorized ZENEC dealer.

ANTI-THEFT PROTECTION

The ZENEC system is equipped with an anti-theft protection function. If this is active, on restarting the ZENEC system after interruption of the power supply you will be asked to enter your password.

To change the password:

Device User Manual → Setup → Device Setup → Password

NOTE

Keep your password safe. If the password is lost the ZENEC system must be uninstalled, and sent back in to ZENEC Service to unblock the anti-theft protection. This service is not free!



See detailed information at page 65

MULTIFUNCTION STEERING WHEEL

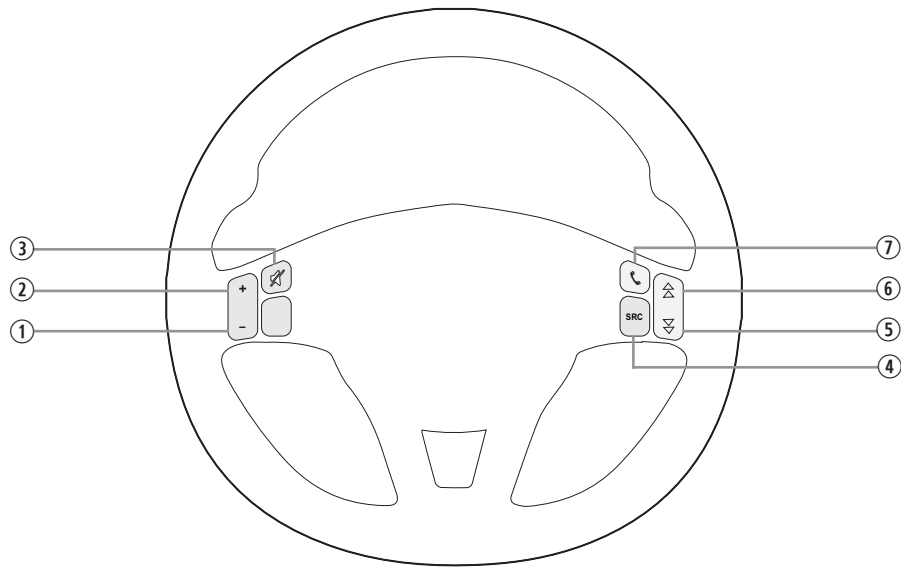

Item	Function	
①	Reduce volume	
②	Increase volume	
③	Mute	
④	Change playback source	
⑤	Radio source	Press to choose the previous radio station
	Media source	Press to choose the previous next track/title Press and hold to fast rewind.
⑥	Radio source	Press to choose the next radio station
	Media source	Press to choose the next track/title Press and hold to fast forward
⑦	Accept/end call	

i NOTE

These functions can only be used when a multifunction steering wheel is present in the vehicle, and the ZENEC system is connected via a car specific CAN/Stalk interface.

Z-N528 (FRONT PANEL)

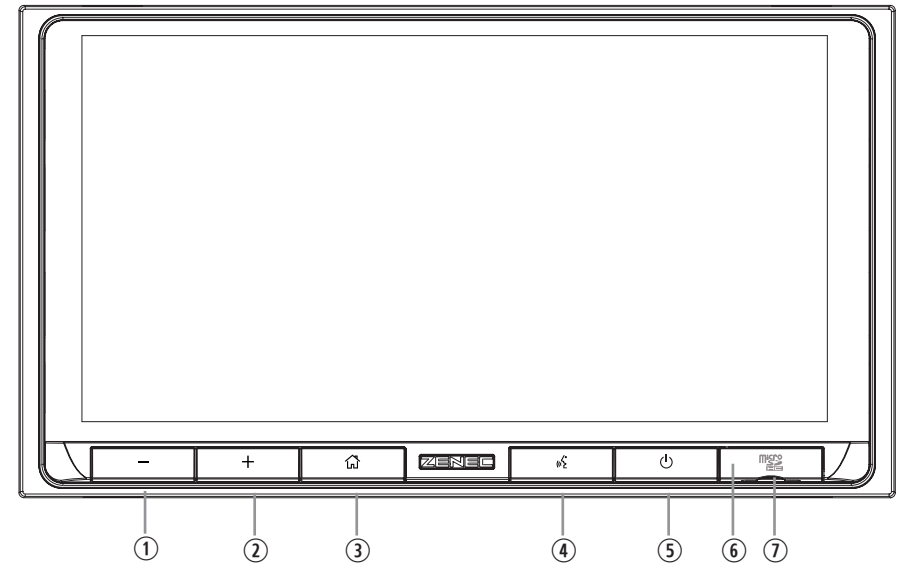





Device Front Panel Control Options

Item	Icon	Function
1	—	Press, or press and hold to decrease the playback volume
2	+	Press, or press and hold to increase the playback volume
3	🏠	Press to jump back to main menu
4	🗣️	Tap to start the Android and CarPlay voice control. Tap once more to cancel the voice control. Tap and hold to restart the voice input.
5	🔌	Press to mute device, press and hold to turn device ON or OFF
6	🌀	Reset pin to perform hardware reset behind the cover
7	microSD	Slot for the microSD with Media Files (Audio & Video)

MAIN MENU ICONS

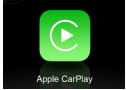





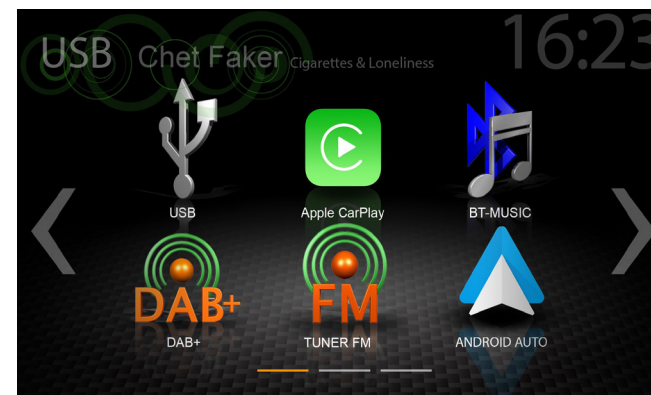

You can navigate through main menu pages by swiping or tapping on the orange page markers in the bottom area of each page.

Function	Icon	Operation
USB		Tap to enter USB source
CarPlay		Tap to start Apple CarPlay
Android Auto		Tap to start Android Auto
DAB+		Tap to open DAB+ radio source
HDMI		Tap to open HDMI source
CAMERA		Tap to open the camera source

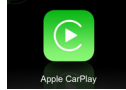
MEDIA AUDIO SOURCES



You can access / enter connected internal or external sources by tapping on the main icon according to the following list.





Function	Icon	Operation
USB		Tap to enter USB source
CarPlay		Tap to start Apple CarPlay
BT-Music		Tap to open BT-Music source
DAB+		Tap to open DAB+ radio source
Tuner FM		Tap to open FM radio source
Android Auto		Tap to start Android Auto
SD		Tap to enter SD source

INPUT SOURCES

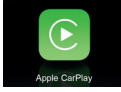

To select and open external sources like HDMI, Camera, AV/IN, CarPlay or Android Auto, they need to be paired or physically connected to the device.

Input Sources

Function	Icon	Operation
HDMI		Tap to open HDMI source
Camera		Tap to enter camera source
Android Auto		Tap to start Android Auto
CarPlay		Tap to start Apple CarPlay
AV/IN		Tap to open AV/IN source



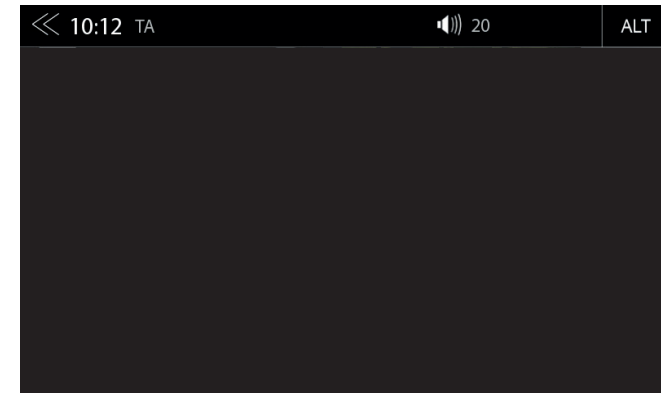

i NOTE

Icons in the main menu remain greyed out for sources not connected to device.

STATUS BAR ("INFO BAR")



The „info bar in the upper hand screen area shows TA, volume and time but also contains two important controls for device operation: BACK (left side) and ALT (right side).

Function	Icon	Operation
Back		Tap to jump one level up or back
Clock Time		Display of time (no interaction possible)
Traffic Announcement		Traffic announcement (if function is set to active)
Volume		Shows the current playback volume
ALT		Tap to select / start a previously assigned function Settings → Misc → ALT Software button

SEARCH AND INPUT FUNCTION

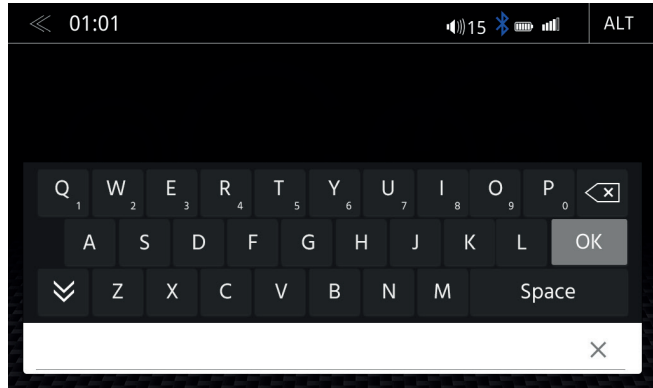

The keyboard for search and input is based on the Linux OS system layout. The system language selection will automatically assign QUERTY or QWERTZ layout.

Function	Icon	Operation
Search input area		Input box Tap to reopen the keyboard
Delete		Tap to delete a number, letter or sign
		Press and hold to delete the full string
Back		Tap to end the search or the input
List view		Tap to show all search results/- full list
Close		Tap to close the keyboard

UKW (FM) RADIO



The FM RDS source menu offers a control-/operating section on the right hand side, for fast and convenient adjustments during the FM radio playback.

Center Section of Display

Function	Icon	Operation
Station forward		Tap to start the auto FM station search, running up in the frequency band
Station		Station Name / Station Frequency
Station back		Tap to start auto FM station search, running down in the frequency band
Cover		Shows radio station graphics or cover picture of artist
Info display area		Finger swiping left and right to access stored FM stations previous / next

Control- and Operating Section

Function	Icon	Operation
FM / DAB Switch		Tap to switch to DAB
Info		Tap to show station information
Frequency Scale		Tap to open FM station frequency bar
Preset		Tap to show the stored FM station list
Tuner Setup		Tuner settings
AS		Tap to start FM auto station search
TA		Tap to activate or de-activate the auto switching of RDS traffic announcements

FM BAR GRAPH MODE



The FM setup mode (press gear icon) allows to assign two different operation modes to both station frequency arrows: manual steps in 100kHz, or auto scan (stopping at next station). See page 18.

Function	Icon	Operation
Station Frequency UP		Tap to start manual 100kHz jump, or FM station auto search up
Station Frequency		Tap to open the direct frequency input mode keypad
Station Frequency DOWN		Tap to start manual 100kHz jump, or FM station auto search down
Bar Graph Scale		Press and hold to slide the frequency pointer of the bar graph into any position. Tap to set a desired frequency value on the scale

MANUAL FM STATION SEARCH



When you tap to the frequency display area, the numeric input keyboard opens for a direct station frequency input.

Function	Icon	Operation
Station Frequency UP		Tap to auto seek / manual seek up, depending on setting
Station Frequency		Tap to open and close direct station frequency input via keypad
Station Frequency DOWN		Tap to auto seek / manual seek down, depending on setting
Scale		Radio frequency scale display
Delete		Tap to delete a number Press and hold to delete the full text string
Keypad		Direct frequency input option
OK		Touch to confirm frequency

Control- and Operating Section

FM / DAB Switch		Tap to switch to DAB
Information		Tap to show station information
Frequency Scale		Tap to open FM station frequency bar
Preset		Tap to show the stored FM station list
Tuner Setup		Tap to change settings for Tuner FM
TA		Tap to activate or de-activate the auto switching of RDS traffic announcements

UKW SETUP (FM)

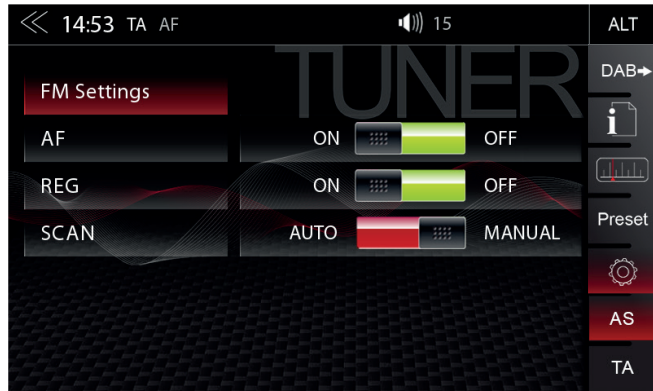

Here you can set important FM RDS based settings such as AF and REG.

Function	Icon	Operation
AF		Alternative Frequency ON / OFF
REG		Setting to keep AF in the regional (local) station tuning mode.
SCAN		Setting to choose the automatic or manual station frequency search.
TA		Tap to activate or de-activate the auto switching of RDS traffic announcements

DAB+ RADIO SETUP

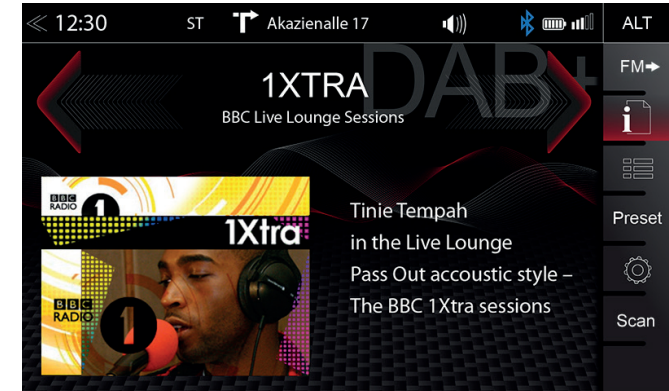

The DAB+ source menu offers a control- + operating section on the right side of the display, allowing for simple and convenient direct adjustments in the playback menu.

Function	Icon	Operation
Station up		Tap to jump to next station Press and hold to jump to next Ensemble
Station		Station Name / Ensemble info
Station down		Tap to jump to previous station Press and hold to jump to previous Ensemble
Slideshow		Radio station artwork / artist display ("MOT Slideshow")
Info Display Area		Finger swiping left and right to switch between Preset stations

Control- and Operating Section

Function	Icon	Operation
UKW / DAB+ Switch		Tap to switch between FM / DAB +
Info		Tap to show station information - main display
List		Tap to open the station list (showing all currently receivable radio stations in the environment)
Preset		Tap to show the stored DAB station list
Setup		Tap to change settings for DAB+ functions
Scan		Tap to start full station search. Press and hold to delete the station list and start station search

DAB+ ENSEMBLE AND STATION LIST



Once the first DAB+ band scan has completed, device will show all DAB+ Ensembles and radio stations of sufficient signal strength. The ensemble list and content can be updated via using the scan button.

Function	Icon	Operation
Ensemble list selection		Tap to open an Ensemble, showing the assigned DAB+ radio station list
List scrolling		Press and hold to move the slider of the Ensemble list up and down
Back		Tap to jump one level back or up



A tap on each Ensemble opens the related DAB+ station list of the respective Ensemble. The station list content follows exactly the original Ensemble display format and list sequence.

Function	Icon	Operation
Radio station selection		Tap to select one particular radio station out of the list
List scrolling		Press and hold to move the slider of the station list up and down

DAB+ SETUP

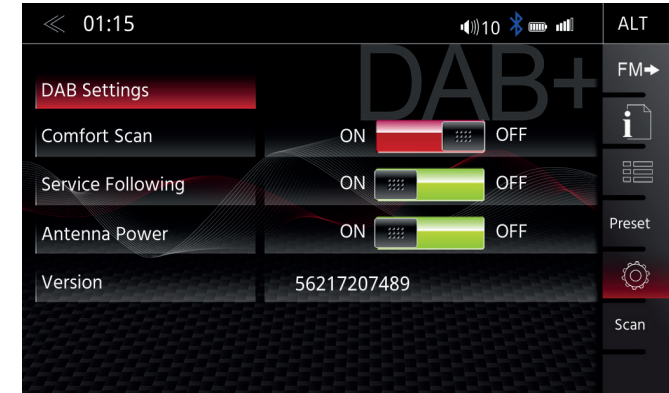

The setup page for the DAB+ tuner allows to define important functions such as DAB->DAB service following. Or to activate the phantom power supply voltage of the DAB antenna socket.

Function	Icon	Operation
Comfort Scan		Tap to turn the comfort scan ON or OFF
DAB-DAB Service Following		Tap to turn DAB-DAB station following ON or OFF
DAB Firmware		Displays the current DAB Firmware version
DAB antenna socket phantom power		Tap to turn the 12V phantom power supply of the DAB antenna socket on the device backside ON or OFF

DAB+ STATIONS-PRESETS

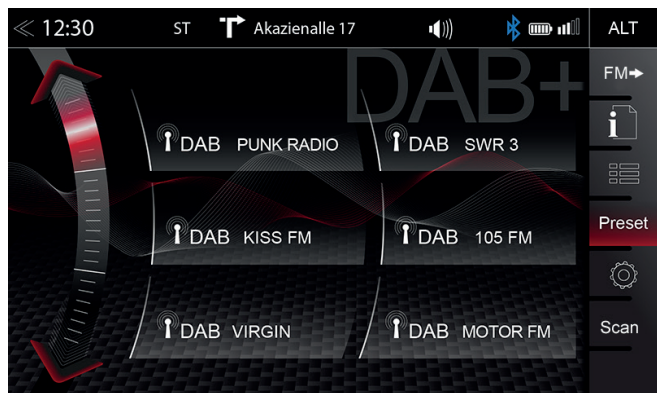

Select a previously stored DAB+ radio station by tapping on the station preset button.

Function	Icon	Operation
Previous page		Tap to switch to previous preset page
Next page		Tap to switch to next preset page
Stores		Tap to select a stored DAB+ station. Press and hold the station to save the actual radio station on any of the station preset buttons

USB / BT A2DP / mSD / IPOD (AUDIO) MEDIA

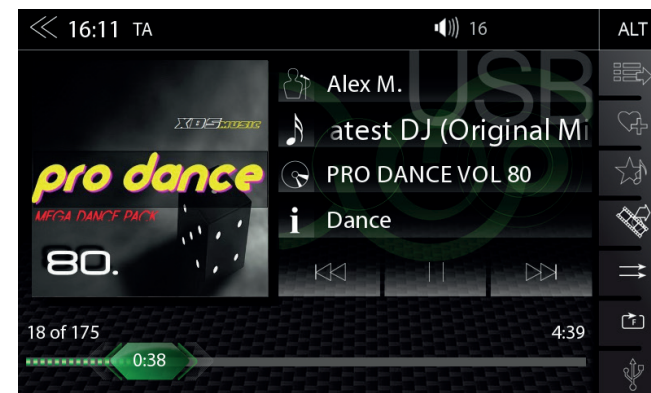

Various types of information shown in the source menu of the audio playback by (USB, BT A2DP, IPOD, etc.).

Function	Icon	Operation
Album, Art / Cover		If a cover is stored on the music media, it can be displayed. This function is not supported for BT Audio playback.
Interpret		Information about the artist
Track		Information about the track
Album		Information about the album
Genre		Information about the genre or any other special infos
Back		Tap to skip to the previous track Press and hold to start fast reverse
		Swipe to the left to skip forwards to the next track
Play		Tap to play a track
Pause		Tap to pause at a track
Forward		Tap to skip to the next track Press and hold to start fast forward
		Swipe to the right to skip back to the previous track
Playback Time Line		Tap or slide to skip within a track

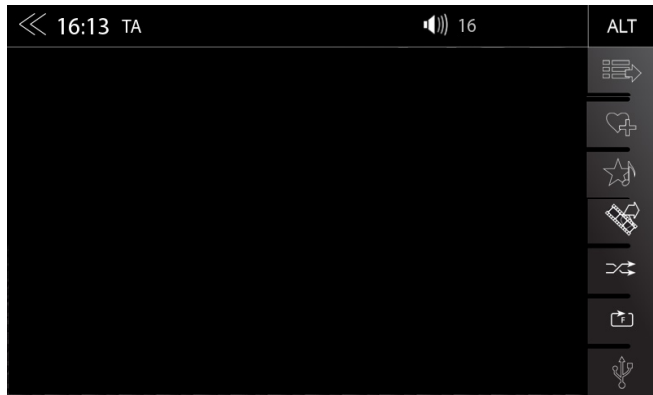

The control and operation bar on the right side of the audio playback media menu continues to play lists, favorites, and external USB memory.

Function	Icon	Operation
Playlist		Tap to display the folder and list This function is not supported for BT Audio playback.
Smart Playlist		Tap to add a track to own playlist This function is not supported for BT Audio and iPod
Favorites		Tap to add a track to FAV playlist This function is not supported for BT Audio and iPod
Video <-> Audio Source		Tap to switch between audio or video playback. This function is not supported for BT Audio and iPod
Shuffle		Tap to turn on the random play feature within the folder that is playing
Repeat		Tap to automatically repeat a track or a complete music collection
Source		Touch to jump to next available source (Available sources USB, iPod and BT-Music)

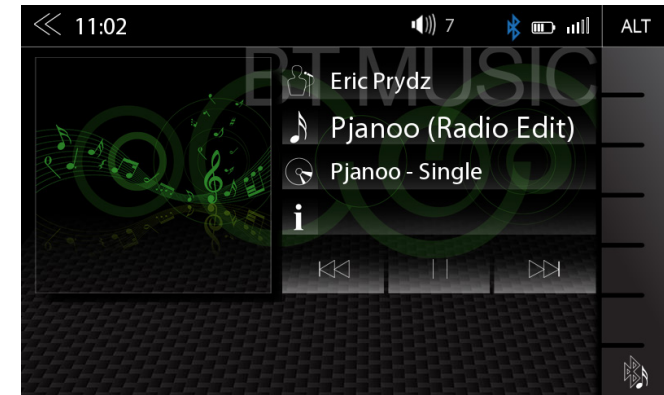

The A2DP RVC interface offers Play, Pause and Skip control of previously paired smartphones in audio playback mode. The iD3-Tag meta data display is possible only when tag data is contained in the streamed music track.

NOTE

The listed functions depend on the paired mobile phone, installed software versions and the degree of compatibility.

iPOD (AUDIO)

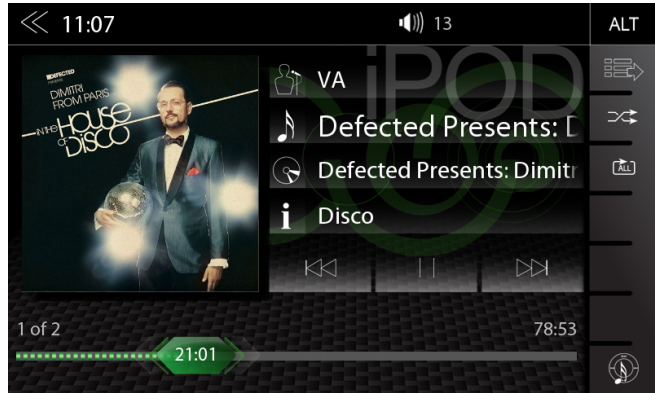

The order of the Artist display of is given by the sorting sequence on the mobile Apple device and can not be changed or adapted in any way.

PLAYLIST (AUDIO)



There are different playlists. We generally differentiate between the standard and special playlists (Smart Playlist and Favorites Playlist).

Function	Icon	Operation
Folder (uppermost)		Tap to go to the next higher level
Folder		Touch to go to the highest folder level Hold to go to the hard disk overview (root)
Song		Listing by song
Interpret		Listing by artist
Album		Listing by album
Smart Playlist		Tap to access the Smart Playlist (Shows created Playlists)
FAV List		Tap to access the FAV playlist
Search		Tap to open search keypad
Scroll		Scroll in the list: Touch and hold to move the slider up or down Tap and hold your finger on the list to move the list up or down

SMART PLAYLIST (AUDIO)

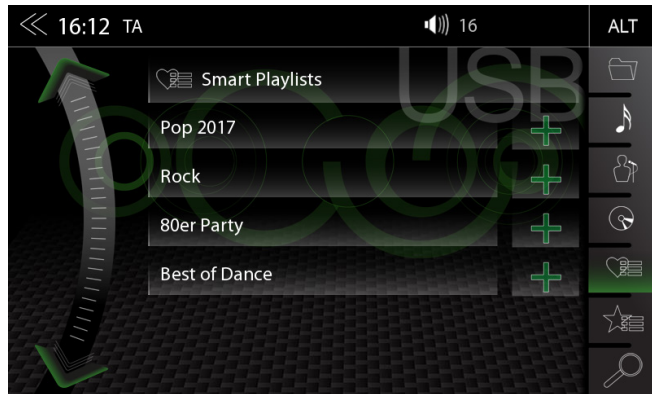

This function allows you to manage the playlists which created by the Smart Playlist function. The playlists can be renamed.

Function	Icon	Operation
Playlist name field		Tap to go to the next higher level
Playlist editing mode		Tap to edit a playlist (editing mode)
		Tap to delete a playlist
		Tap to rename a playlist
		Tap to cancel playlist edit mode
Song editing mode		Tap to edit a song within a playlist (editing mode)
		Tap to delete a playlist song
		Tap to move a playlist song (Add a song to another playlist)
		Tap to cancel edit mode
Scroll		Scroll in the list: Touch and hold to move the slider up or down Tap and hold your finger on the list to move the list up or down.

FAV PLAYLIST (AUDIO)

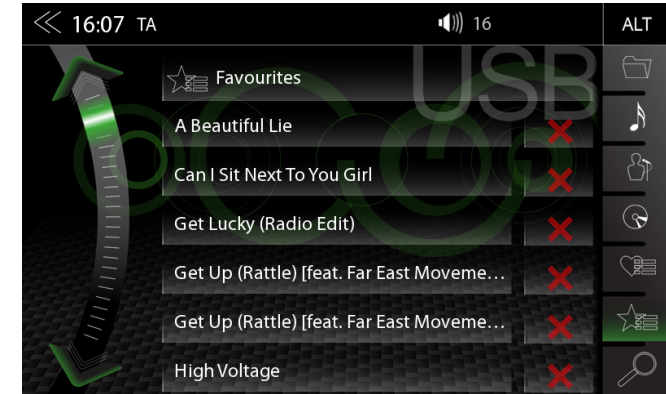

This playlist feature allows you to add a song easily and quickly to a fixed favorite playlist.

Function	Icon	Operation
Playlist name field		No function, text field only. Note: The name of the FAV playlist can not be changed.
Delete		Tap to delete a FAV playlist song
Scroll		Scroll in the list: Touch and hold to move the slider up or down Tap and hold your finger on the list to move the list up or down.

VIDEO MEDIA: HARDDISK

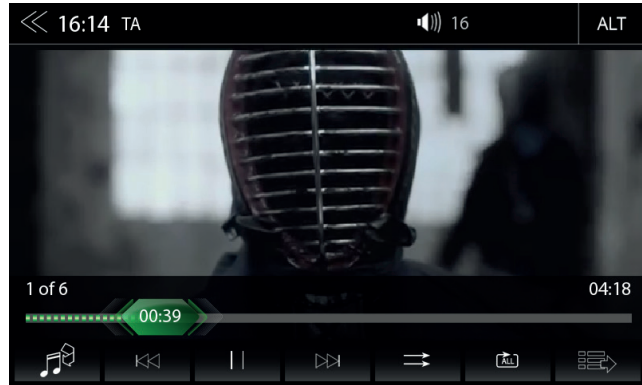

For video playback via USB, parking cable must be connected during the device installation. Without this connection, the screen remains black.

Function	Icon	Operation
Jump inside Title		Tap to skip directly to the desired position Slide to reach the desired position
Video<->Audio Source		Tap to switch between audio or video playback. This function is not supported for BT Audio and iPod
Back		Tap to skip back to the previous section
Play		Tap to play a film
Pause		Tap to pause a film
Forward		Tap to skip forward to the next section
Playlist		Tap to display the folder and list This function is not supported for BT Audio
Shuffle		Tap to turn on the random play feature within the folder that is playing
Repeat		Tap to automatically repeat a film or complete video collection

PLAYLIST (VIDEO)

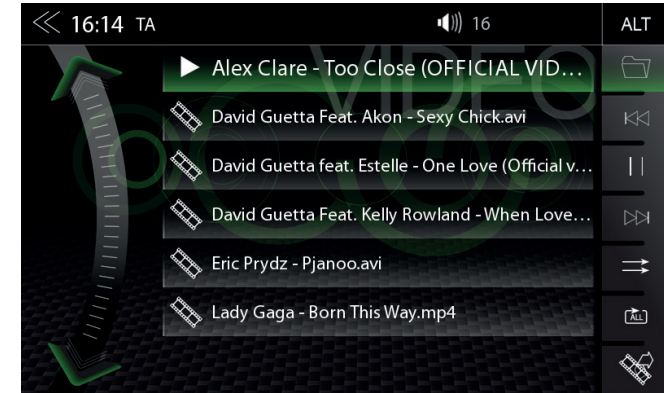

Playlist (Video) displays the video files on the USB data carrier with their file name. In this list sliding up or down is easily possible.

Function	Icon	Operation
Folder		Touch to go to the highest folder level Hold to go to the hard disk overview (root)
Back		Tap to skip back to the previous section
Play / Pause		Tap to play a film or a video Tap to pause a film or a video
Forward		Tap to skip forward to the next section
Shuffle		Tap to turn on the random play feature within the folder that is playing
Repeat		Tap to automatically repeat a film or complete video collection
Video <-> Audio Source		Tap to switch between audio or video playback. This function is not supported for BT Audio and iPod
Scroll		Scroll in the list: Touch and hold to move the slider up or down Tap and hold your finger on the list to move the list up or down



CAUTION

Playing video files while driving is not permitted by the law. For this reason the screen will switched off when the vehicle moves, with the playback of sound only.

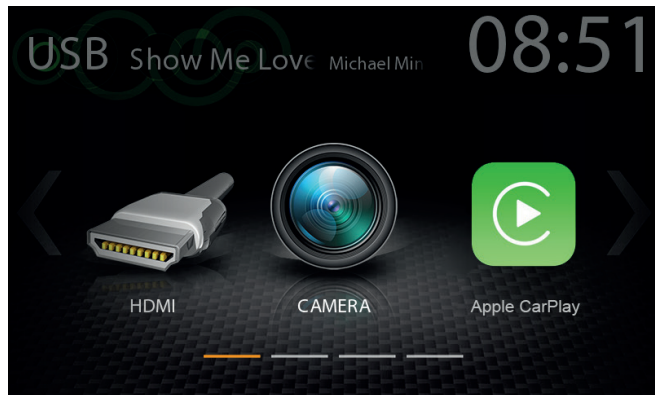
HDMI





Tap to the HDMI icon starts the A / V source, if a compatible HDMI source connected, for example a videogame, smartphone, tablet, notebook.

Function	Icon	Operation
HDMI		Tap to open HDMI source mode
AV/IN		Tap to open the A/V IN source

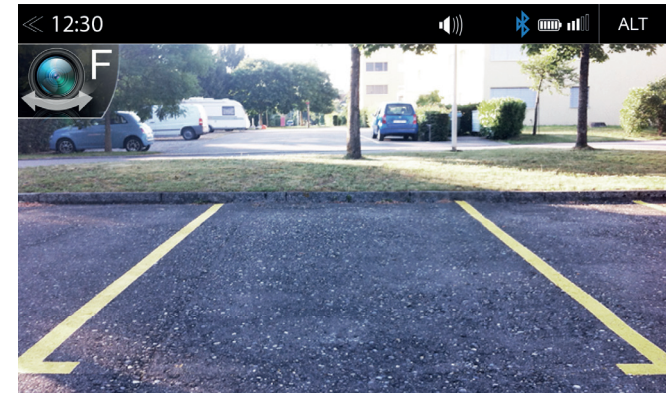
CAMERA



Tapping the camera icon starts the manual camera mode, if a CVBS capable camera is connected to the camera input of the unit.

Function	Icon	Operation
Camera switching		Tap to switch between the front and rear camera
Camera		Tap to open camera source
Settings		Tap to adjust the lines

CAMERA GRID-LINES: ZENEC TYPE

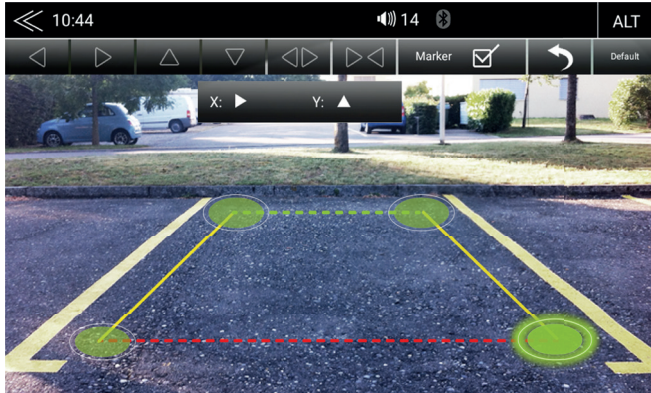

Comfortable parking assistant with variably adjustable camera grid lines for their own individual attitude.

Function	Icon	Operation
Presentation	Marker <input checked="" type="checkbox"/>	Tap to show or hide the lines
Grid-Line area		Display the grid lines with the arrows and circles the lines can be positioned.
Back		Tap to exit the settings menu
Together		Tap to narrow the field
Apart		Tap to widen the field
Up		Tap to bring the field nearer
Down		Tap to push the field away
Default setting		Tap to set the lines to the default setting and positions
Corner points		Press and hold to move an corner point to the desired position
Corner point – move left		Tap to move left the corner point
Corner point – move right		Tap to move right the corner point
X/Y coordinates	X: Y:	Display the current X/Y coordinates

NOTE

To calibrate the assist lines, reverse parallel to the parking space stripes and centrally to the start of the parking space.

USING ANDROID AUTO

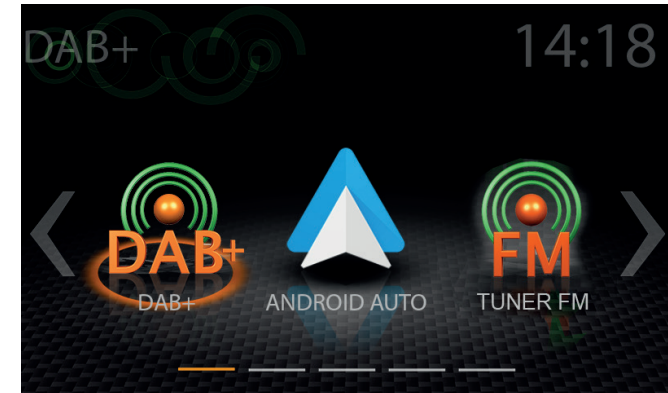

With Google Android Auto, you are able to access compatible apps and online services of your Android smartphone in your motor home and operate them intuitively with the display of your ZENEC device or the voice assistant from Google.

USING ANDROID AUTO

PREPARATION:

- Download the Android Auto app from the Google Play Store.
- Connect the Android smartphone with the USB 1 connector of the ZENEC device.
- To use the hands-free function of Android Auto, connect the Android smartphone with the ZENEC device via Bluetooth. Please pay attention to chapter „Bluetooth (Hands-free System) → Pairing“.

INITIAL OPERATION:

1. For the initial operation, the vehicle must not be in motion and the hand brake must be put on.
2. Tap to the Android Auto icon in the main menu of the ZENEC device to choose the Android Auto source.
3. Follow the dialogue on the display of the ZENEC device to install Android Auto and to configure the start behaviour. It is possible to change the selected start behaviour in the setup operations anytime later. Please pay attention to chapter „Setup Operation → Misc → Launch Android Auto“.
4. After the initial operation has been completed successfully, the Android Auto user interface appears on the screen of the ZENEC device.

ANDROID AUTO OPERATION

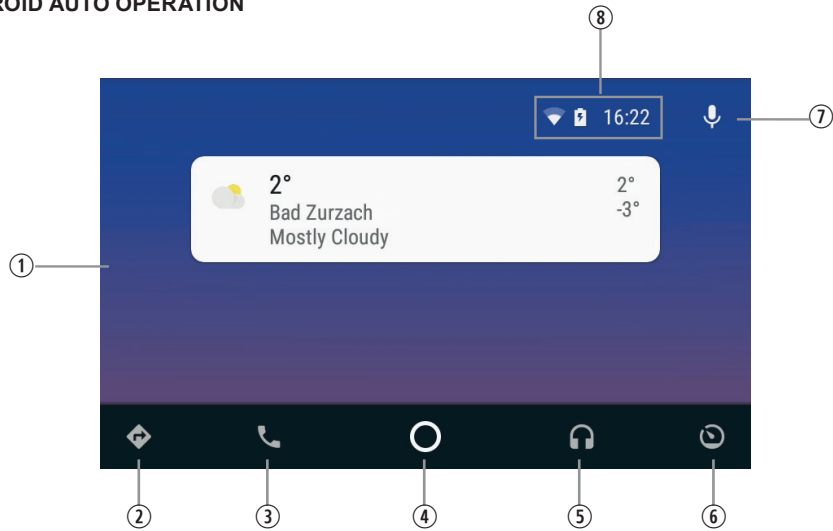

Item	Icon	Operation
1		Android Auto user interface
2		Navigation
3		Telephony
4		Open Android Auto user interface
5		Media playback
6		Open ZENEC main menu
7		Activate Android Auto voice control
8		Smartphone status information (can vary depending on the model)

i NOTE

- Android Auto may not be available on all devices and is not available in all countries and regions.
- To use Android Auto with your Android Smartphone, at least Android 5.0 (Lollipop) or a higher version of the Android operation system must be installed on your smartphone.
- To use Android Auto on your ZENEC device, you have to adjust time and date on your ZENEC device correctly. Please pay attention to chapter „Setup Operations → System → Clock & Date Setup“.
- For more detailed information about Android Auto, please visit <https://www.android.com/auto/> and <https://support.google.com/androidauto#topic=6348027>

APPLE CARPLAY



CarPlay is an optimal co-pilot inside the car, on safer way to use your iPhone in the car. CarPlay takes the things you want to do with your iPhone while driving and puts them on your car's built-in display. You can get directions, make calls, send and receive messages, and listen to music, all in a way that allows you to stay focused on the road. Just connect your iPhone and go.

USING APPLE CARPLAY

PREPARATION:

- Connect the compatible iPhone with the BACKSIDE USB-1 connector of the ZENEC device.
- Bluetooth will be automatically establish on BACKSIDE USB first time connection.
- Unlock your iPhone.

INITIAL OPERATION:

1. For the initial operation, the vehicle must not be in motion and the hand brake must be put on.
2. Tap to the CarPlay icon in the main menu of the ZENEC device to choose the CarPlay source.
3. After the initial operation has been completed successfully, the CarPlay user interface appears on the screen of the ZENEC device.

APPLE CARPLAY OPERATION

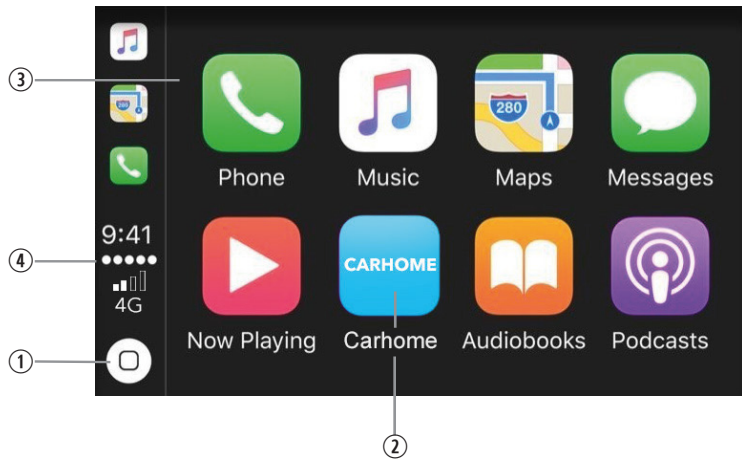

Item	Icon	Operation
1		Tap to display the home screen of CarPlay
2		Tap to open the ZENEC main menu
3		Tap any of the APP icon to start the application
4		iPhone status information

i NOTE

- CarPlay isn't available on older iPhones..
- To use CarPlay with your iPhone, at least iOS 7.1.x or a higher version of the Apple operation system must be installed on your phone.
- For more detailed information about Apple CarPlay, please visit <https://www.apple.com/de/ios/carplay/>

BLUETOOTH (HANDS-FREE SYSTEM)

ABOUT THIS CHAPTER

This chapter describes how to operate and use the hands-free system. In addition, all the equipment variants and functions of the ZENEC BT system are described.

SAFETY INSTRUCTIONS

⚠ CAUTION

Using the mobile phone with the hand while driving is not permitted. Only enter data or make changes via the ZENEC system when the traffic situation allows such actions.

⚠ CAUTION

Network coverage depends on a number of factors – such as the network provider, or the geographical position of the vehicle. Tunnels, underpasses, parking garages, or street canyons in cities may lead to interruption of the connection. Thermal glazing or metallic stickers on the windows of the vehicle may also disrupt the connection.

CONTROL AND OPERATION BAR (RIGHT)



The vertical control and operation bar on the right area of the Bluetooth page serves to invoke device manager, or access phone book, favorites, call logs, numeric keypad, Bluetooth settings and Scan (BT device search).

Function	Icon	Operation
Device manager		Tap to access the device manager view
Phonebook		Tap to access the phonebook of the currently paired mobile phone
Favorites		Tap to access the stored favorites
Call logs		Tap to access the call logs
Numeric pad		Tap to open the numeric keypad
Bluetooth setup		Tap to change the most important settings for BT operation
SCAN (Search)	Scan	Tap to search a new Bluetooth device

DEVICE MANAGER

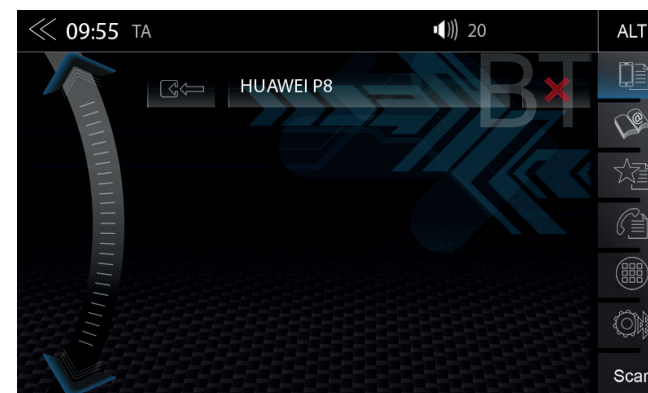

The BT function on the device must be activated to invoke connection process. Please pay attention to the smartphone manufacturer's instructions regarding device pairing.

Function	Icon	Operation
Device manager		Tap to pair, disconnect, or manage mobile devices

Function	Icon	Operation
Pair		Tap to reconnect a paired Bluetooth device
Disconnect		Tap to disconnect a paired Bluetooth device
Delete		Tap to delete a Bluetooth device from the list (requires the device to be disconnected)

Icon	Meaning
	This icon indicates that the paired Bluetooth device supports HSP/HFP, and can be used via the hands-free system.

PAIRING

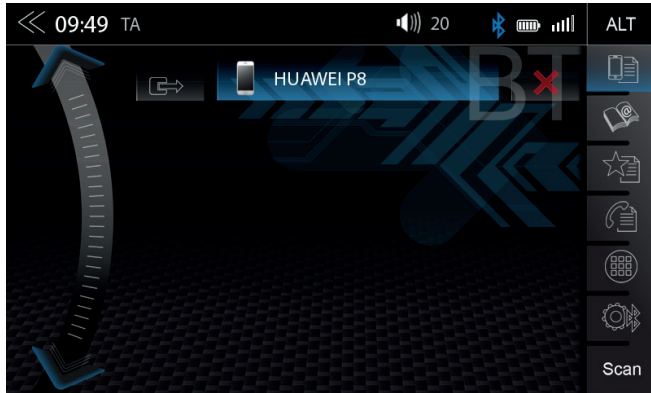

To connect a smartphone to the Zenec device via Bluetooth, first step is to successfully complete the pairing process.

Via ZENEC system

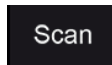
Function	Icon	Operation
Scan (Search)		Tap to the SCAN icon to initiate a search for BT devices. Re-tap to stop the search and show the device-list. Select from the list the desired mobile device that you want to synchronize with the ZENEC system. Once device is selected, follow the instructions.
Code		Standard Code*: 0000

NOTE

*For mobile devices that do not support the SSP standard

Via the mobile device

Function	Icon	Operation
Search		Make sure that the ZENEC system is in Device Manager view otherwise the ZENEC system will not be visible to others. Follow the instructions of the device manufacturer on pairing.

Auto Connect

Once a mobile device has been connected with the ZENEC system, it will be automatically paired when the ZENEC system is started. On being briefly disconnected the ZENEC system will attempt to establish a new connection.







NOTE

On pairing for the first time, be sure to permanently enable the connection confirmation on your mobile device, otherwise malfunctions may occur during the Auto Connect process.

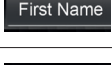

BLUETOOTH SETUP



On the Bluetooth setup page you can adjust settings for Bluetooth operation. Press the appropriate button / field to change any of the listed settings.



Function	Icon	Operation
Bluetooth Settings		Tap to change settings for BT operation
Auto Connection		ON / OFF
Contacts Order		1. by first name of contact 2. by surname of contact
Microphone Gain		Tap to set the Mic. gain from 0 to 12
Bluetooth Address		Unique ZENEC BT device address.
Auto Answer		ON / OFF ON = Automatic call acceptance (after 3 ring tones) activated OFF = Automatic call acceptance deactivated
Auto Load Phonebook		ON / OFF

BLUETOOTH STATUS BAR

Icon	Function
	Mobile phone currently connected
	Battery capacity of the mobile phone currently connected
	Signal strength of the current mobile network

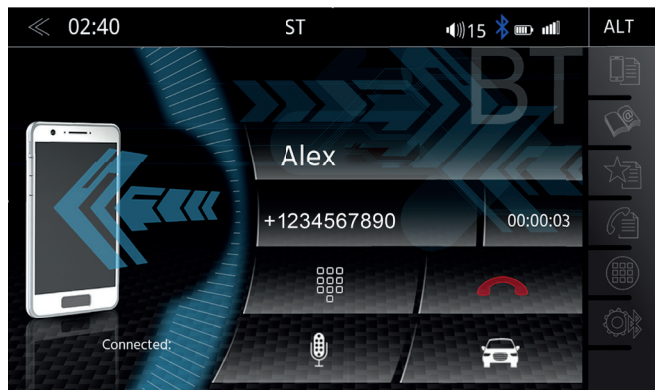
ACCEPTING/ENDING INCOMING CALLS (VIA DEVICE)



Function	Icon	Operation
Accept		Tap the green handset to accept the call
Reject		Tap the red handset to reject the incoming call
End		Tap the red handset to end the call

DIAL A CALL USING NUMERIC PAD

In the control-/operation panel touch the  numeric pad.

Key in the desired phone number in full using the numeric pad. To set up the connection, touch . The display now changes to the call connection view.

DIAL A CALL USING PHONEBOOK





In the control-/operation panel touch the  phonebook.

From the phonebook list select a call partner and set up a connection by touching . After touching a contact you will be directed to the contact details view.

i NOTE

Depending on the mobile phone and phonebook entries, the first synchronization can take up several minutes.

BLUETOOTH MENU

Function	Icon	Operation
Discrete		Touch to pass the call from the hands-free system to the mobile phone or vice versa
Mute conversation		Voice output muted/- unmuted
Numeric pad		Tap to show the numeric pad Necessary in case asked to enter a further number during the call (telephone call center etc.)
Back		Tap to jump back to the previous level

i NOTE

To be able to use the phonebook or call lists without any problems, make sure that during the pairing process you confirm data access enable to the mobile phone.

PHONEBOOK

Contacts

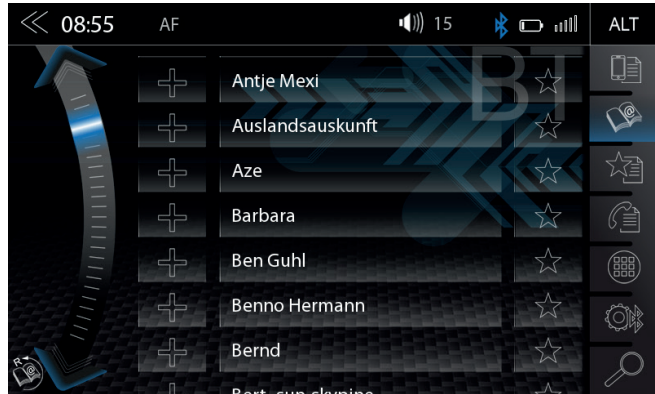

After successful pairing of the smartphone with subsequent phone book synchronization, the device will show you the full contact list. You can add contacts directly to Favorites if you like.

Function	Icon	Operation
Search		Tap to open the contact search keypad
Scroll		Scroll in the list: Touch and hold to move the slider up or down, showing letters by the alphabet.
Phonebook Contacts		Tap to jump to the contact list. Up to 1000 contacts per paired mobile phone can be synchronized; it makes no difference whether the contacts are stored in the phonebook or on the SIM card.
Favorites		Tap to to show phone numbers of the respective contact entry
Call / Accept		Tap the green handset to set up/- start the call
Add Favorite		Tap to add a new Favorite Re-tap to remove a Favorite
Re-sync.		Re-synchronisation of the whole phonebook

CALL LISTS

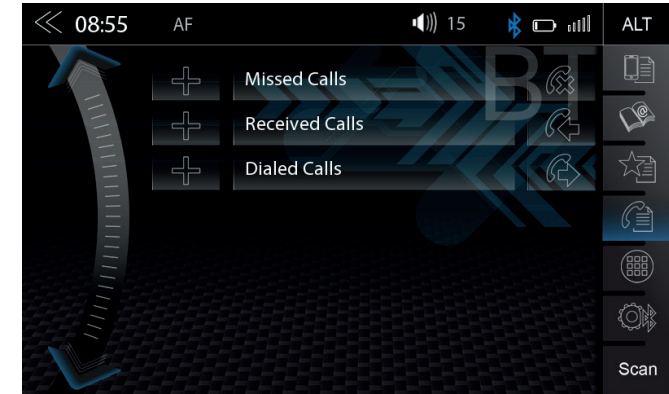

If a compatible mobile phone is connected, call lists from the mobile phone will be synchronized with the BT hands-free system (process can take some minutes, depending on the number of contacts). Once sync process has completed you will be able to access the following logs:

Function	Icon	Operation
Call logs		Tap to see all call logs
Missed Calls		Tap to see the missed calls only
Received Calls		Tap to see the received calls only
Dialed Calls		Tap to see the dialed (outgoing) calls only

Function	Icon	Operation
Missed		Entries with this icon refer to calls that you missed
Incoming		Entries with this icon refer to accepted incoming calls
Contacted		Entries with this icon refer to outgoing calls

FAVORITES

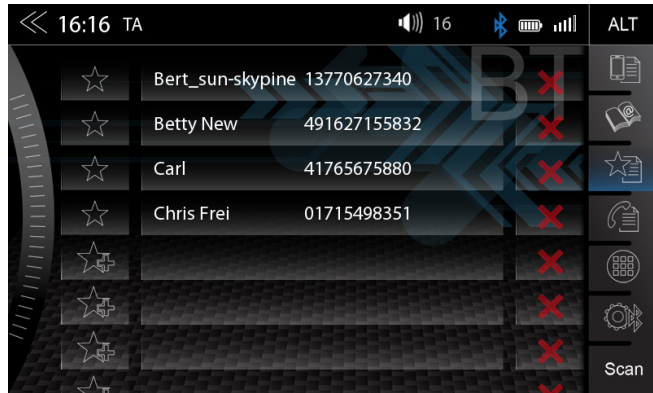

On this page you can link eight or more phone numbers to become favorites. You can select any of the phone numbers in the phonebook and save them as Favorites; the only exceptions are e-mails and addresses.

i NOTE

All Favorites are visible to every user of the device as they are saved in device memory.

Function	Icon	Operation
Stored Favorite		Tap to set up/- start a connection with a stored Favorite
Assign New Favorite		<ol style="list-style-type: none"> ① Tap to add a new favorite ② Select desired number from phonebook and confirm with this ☆ icon
Delete		Tap to remove a stored Favorite

i NOTE

A change of data on the mobile phone will not sync automatically with the stored Favorites. Should you want to change phone numbers this change must be manually transferred to Favorites by deleting the existing Favorite and re-assigning the new number.

SETUP OPERATIONS



This chapter describes all the parameter and setting functions of the ZENEC system. Please note that settings or changed parameters can have a direct influence on the everyday use of the ZENEC system.

Function	Icon	Operation
Setup		Tap to access the setup mode

DISPLAY ICON







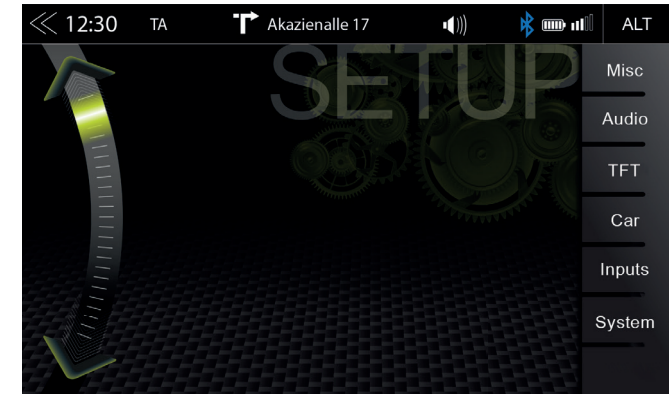

With the display icon, the LCD TFT screen picture brightness can be dimmed or switched off (standby) in two steps. This is done by tapping the icon.

Function	Icon	Operation
Disp		Tap to dim or brighten up TFT screen (☞ 100% → 50% → 0% "standby" ☜)

SETUP OF SOURCES



When you tap the setup icon, you will enter this setup source page, which offers six different sources you can adjust for personal preferences.

Function	Icon	Operation
Misc		Tap to access diverse device settings
Audio		Tap to access sound settings
TFT		Tap to access display settings
Car		Tap to access car settings (Park Assist etc.)
Inputs		Tap to access TFT inputs settings
System		Tap to access system settings

MISC SETUP

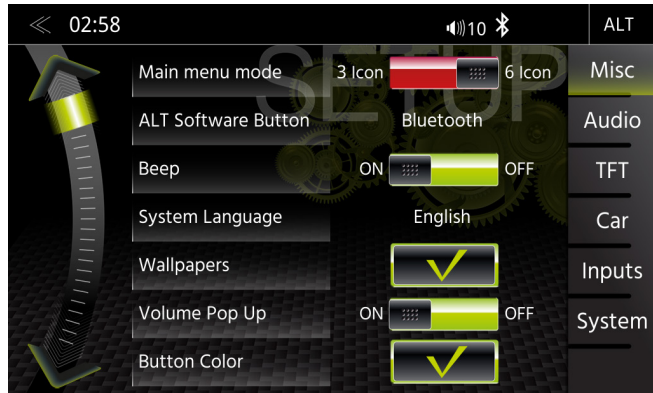

In the Misc menu page, you can configure diverse settings for the display mode with 3 or 6 icons, ON/OFF of the beep sound, as well as the LED color of the lighting of the buttons or sensor buttons on the device front.

Function	Icon	Operation
Misc		Tap to access basic settings view
Main Menu Mode		Tap to switch to 3 Icon or 6 Icon main page display layout
ALT Software Button		Touch to link source or function to ALT (HMI) button (CAM/Mute/Apple CarPlay/Android Auto/Tuner/EQ/Setup/BT-Music/BT/ DISP/iPod/USB/HDMI)
Button sounds		ON / OFF Off = acoustic acknowledgment disabled On = acoustic acknowledgment enabled
OSD Language		Tap to change the menu language
Button Color		Tap to adjust hard key or sensor field illumination
Wallpapers		Tap to change the background image
Volume Pop-Up		ON / OFF Off = visual volume pop-up disabled On = visual volume pop-up enabled
Apple Connectivity		CarPlay / iPod USB 1 Port definition for iPod or CarPlay usage
EasyDrive Mode		ON / OFF Off = EasyDrive Mode disabled On = EasyDrive Mode enabled

AUDIO SETUP

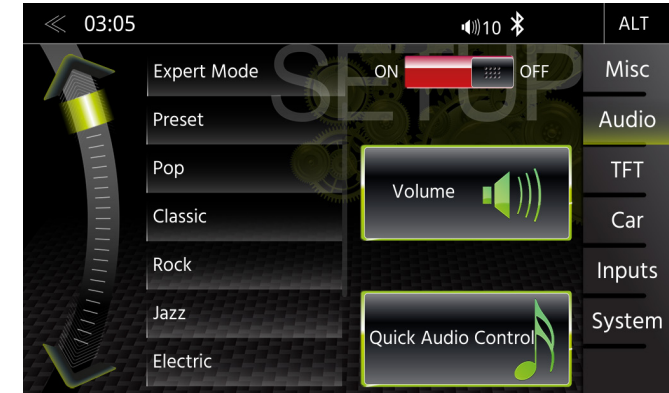

In the Audio menu page, you can adjust settings around the sound, e.g. Volume of the sources, loudness, bass and treble, etc.. The "Expert Mode" view extends the setting options by few points.

Function	Icon	Operation
Audio		Tap to access and configure audio settings
Presets		Tap on one of the presets to change profile (Pop / Classic / Rock etc.) All changes made in the Expert Mode at the Equalizer will be stored under the preset "User".
Expert Mode		Tap to enable or disable expert mode. Tap to make advanced sound configurations.
Volume		Tap to set initial and source volume levels
Audio Control		Tap to access quick audio settings (Loudness / Bass Boost etc.)

VOLUME SETUP

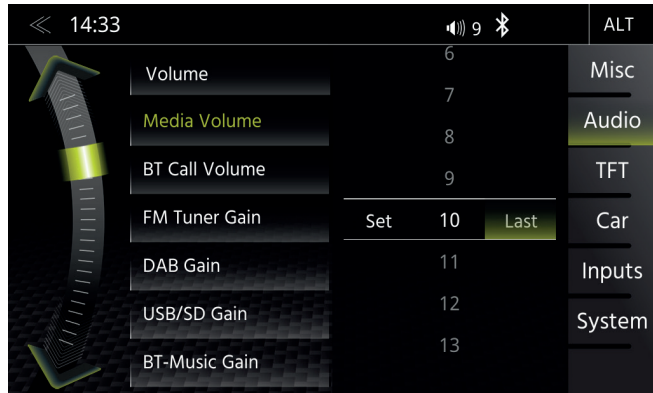

In the Audio menu -> Media Volume, you can customize the basic settings of each source individually.

Function	Icon	Operation
Media Volume		Main volume change requires upper setting position set to "Select". Setting = manually adjusted volume Last = last volume set before switching off
BT Call Volume		BT Call volume change requires upper setting position set to "Select". Setting = manually adjusted volume Last = last volume set before switching off

Fine adjustment of the volume of all "Gain" sources

Function	Icon	Operation
BT Music Gain		Fine adjustment of BT Music volume
FM Tuner Gain		Fine adjustment of FM volume
DAB Tuner Gain		Fine adjustment of DAB volume
USB Gain		Fine adjustment of USB volume
iPod Gain		Fine adjustment of iPod volume
A/V IN Gain		Fine adjustment of A/V IN volume
HDMI Gain		Fine adjustment of HDMI volume

QUICK AUDIO SETUP (BAL / FAD / SUBWOOFER / LOUDNESS / BASS BOOST)

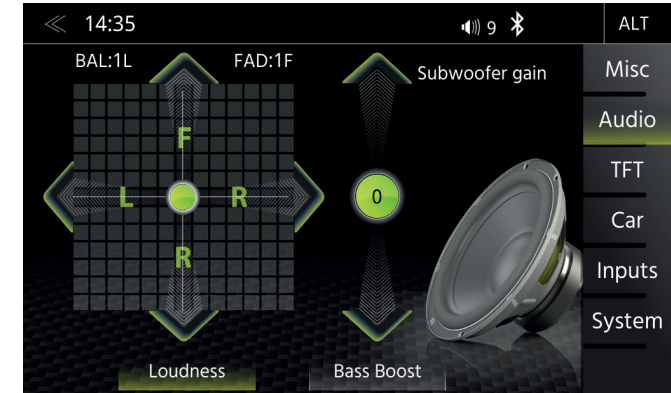

In this menu, you can adjust the Balance / Fader, Loudness and Subwoofer level of the speakers in the vehicle.

Function	Icon	Operation
Left/Right		15 > 0 < 15
Front/Rear		15 > 0 < 15
Loudness		ON / OFF
Bass Boost		ON / OFF
Subwoofer		-6 < 0 > 6

AUDIO SETUP: EXPERT MODE



In the Audio Setup menu page with the Expert Mode set to “ON”, you can change audio relevant settings. Such as Equalizer, Crossover, Time Alignment, etc. Please refer to the listings on the following pages.

Function	Icon	Operation
Expert Mode		Tap to enable or disable expert mode
Volume		Tap to set start and source volume
Balance/Fader		Tap to set fader or balance
Equalizer		Tap to set the 8-BAND equalizer
X-Over		Tap to make settings for the crossover
Subwoofer		Tap to set subwoofer settings
Quick Audio Control		Tap to make general quick audio settings (Loudness / Bass Boost etc.). Can be accessed by long press of the Home button.
Time Alignment		Tap to adjust the time alignment

Volume Setup: see page 51

AUDIO VOLUME – BASE LEVEL SETUP

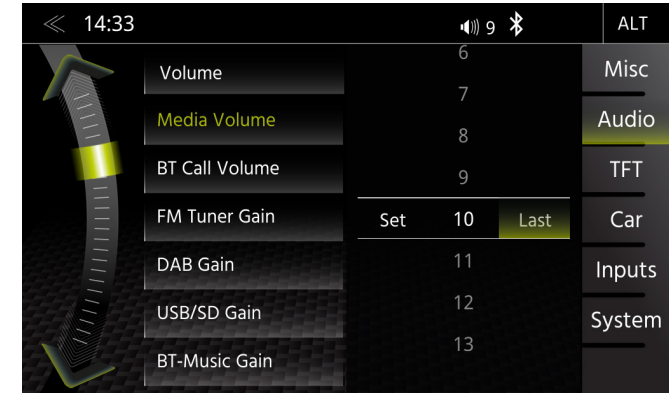

In the audio menu, you can adjust the basic volume values of the various audio sources.

Function	Icon	Operation
Volume		Tap to set the system main startup volume
Media Volume		Tap to set the media playback volume
BT Call Volume		Tap to set the volume of the Bluetooth handsfree volume

BALANCE / FADER

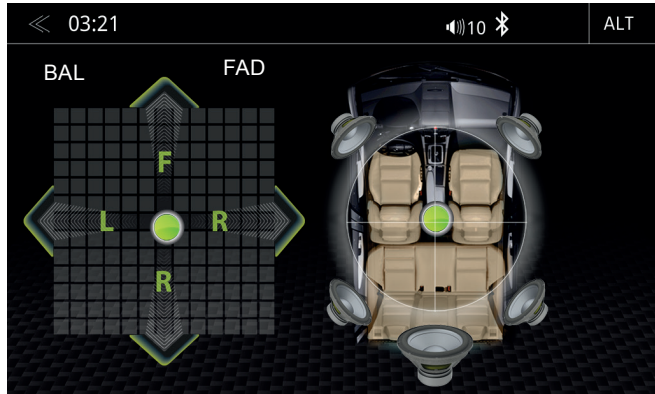

In this Expert Mode menu page, you can adjust the balance and faders. Press and hold the green dot of the crosshair to move sound center position into any desired position.

Function	Icon	Operation
Left/Right		15 < 0 > 15
Front/Rear		15 < 0 > 15
Crosshair		Press and hold to move green dot into desired position

EQUALIZER

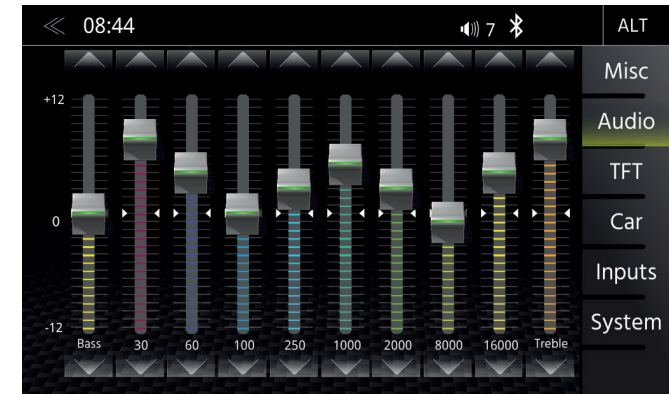

In this Expert Mode menu page, you can set the 8-band graphical equalizer. Press and hold the individual band level sliders to move it up or down for a level change.

Function	Icon	Operation
		Tap to set the desired BAND
Band		Touch and hold to change the setting of the selected band

X-OVER SETUP

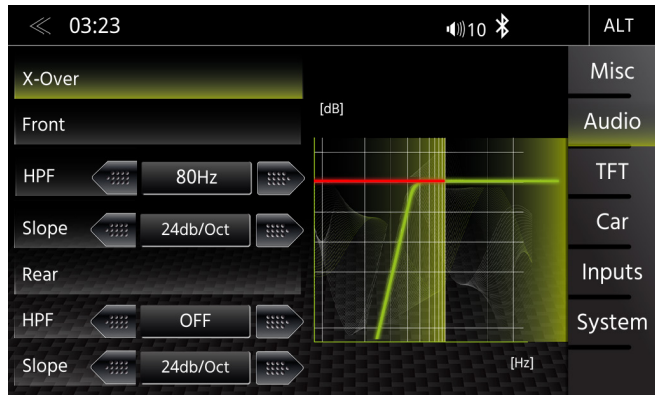

In this Expert Mode menu, you can adjust the High-pass transition frequencies of the front and rear speakers. The factory default is OFF for front and rear speakers.

Function	Icon	Operation
HPF (Front)		Tap to set the high pass filter for front speaker OFF/ 50 Hz /63 Hz/80 Hz/100 Hz/120 Hz
Slope		12/24 dB/Oct.
HPF (Rear)		Tap to set the high pass filter for rear speaker OFF/ 50 Hz /63 Hz/80 Hz/100 Hz/120 Hz
Slope		12/24 dB/Oct.

SUBWOOFER SETUP

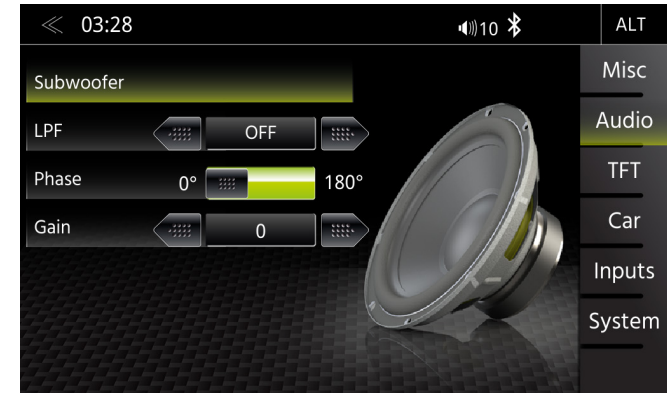

In this Expert Mode menu, you can adjust Phase, Gain, and Low-pass transition frequencies of the subwoofer. The default settings are Phase 0°, GAIN "0", LPF OFF.

Function	Icon	Operation
LPF		Tab to set the low pass filter OFF/ 240 Hz/ 160 Hz/ 120 Hz/ 85 Hz/ 55 Hz
Phase		SUBWOOFER ONLY 0/180° (inverted phase)
Gain		Touch to set the GAIN -6 < > 6

TIME ALIGNMENT

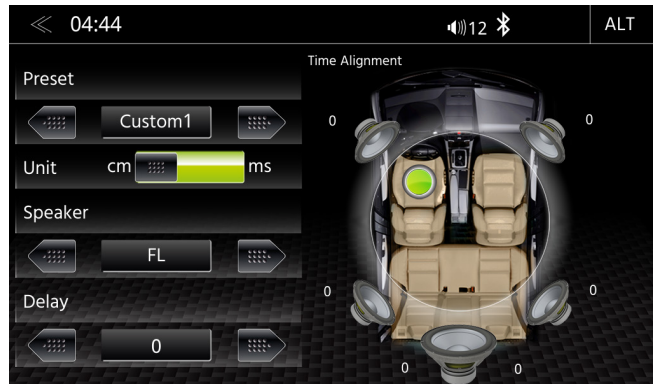

In this menu you can set the time delay correction for the loudspeakers in your vehicle.

Function	Icon	Operation
Unit	◀ ▶	Selection of desired unit ms = time cm = distance
Speaker	◀ ▶	Tap to select the desired speaker (FL / FR / RL / RR / SW)
Delay	◀ 0.0 ▶	ms = 0.0 <> 20 in approx. 0.1 ms steps cm = 0 <> 680 in approx. 3 cm steps

The distance between the ears and the speaker system installed in the vehicle varies considerably due to the given arrangement of the factory mounting location. This menu gives you the option to delay the audio signal at each of the speakers so that you have a "center stage" effect.

Set your central listening position. Measure the distance from this position to each speaker. Now you need to add the corresponding delay - depending on the speaker with highest distance - to move the speakers to same distance from selected position. Enter these distance to let all speakers have the same distance. You can fine tune values by "ear" after the distances from listening position to each speaker have been entered, simply by adjusting the left front speaker delay until center stage position is reached.

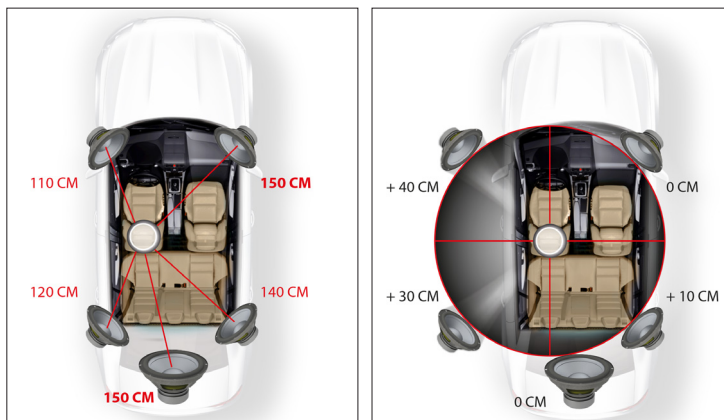

TFT DISPLAY CONFIGURATION

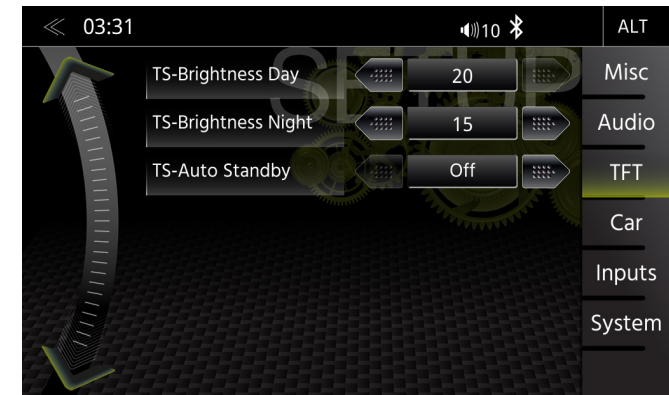

In the TFT Setup menu you can make screen settings that control the day/night brightness of the TFT LCD display screen.

Function	Icon	Operation
TFT configuration	TFT	Tap to adjust display configuration
TS-Brightness Day	◀ 20 ▶	Day adj range 0 ~ 20
TS-Brightness Night	◀ 15 ▶	Night adj range 0 ~ 20
TS-Auto Standby	OFF	Tap to enable or disable TFT Auto Standby function and Auto Screen shutdown. TFT goes into standby after selected time.

NOTE

Using the DISP button you can set the display brightness to three levels (◀ 100% → 50% → 0% ▶).

CAR (VEHICLE) SETUP

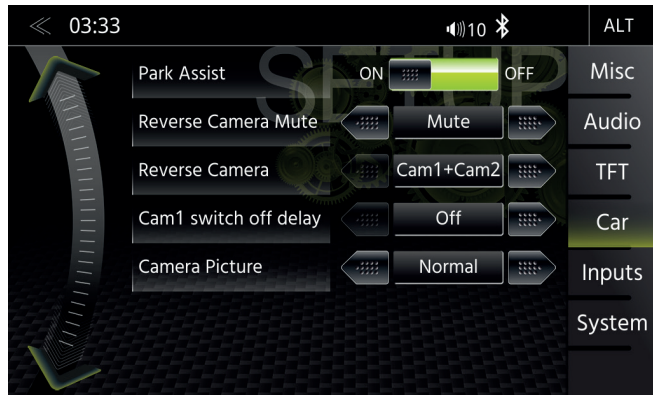

In the Car Setup menu, you can set how the ZENEC device interacts with optional components such as cameras and parking assist inside the vehicle.

Function	Icon	Operation
Car (vehicle)		Tap to access vehicle configurations
Park Assist		Tap to set the parking aid display source. CAM / OFF CAM = Camera On OFF = Camera Off
Reverse Camera Mute		Tap to set the muting function when parking aid is active. OFF / reduced Volume / MUTE Audio
Reverse Camera logic		Tap to set camera switching logic. CAM-1 • Direct camera 1 CAM-2 • Direct camera 2 CAM1 + CAM2 Camera switching between CAM1 & CAM2. Time can be set by "Reverse CAM off Delay"
Reverse CAM Off Delay		Tap to set the Camera off delay time
Camera Picture		Tap to invert the CAM picture (Normal / Invert)

INPUT SETUP

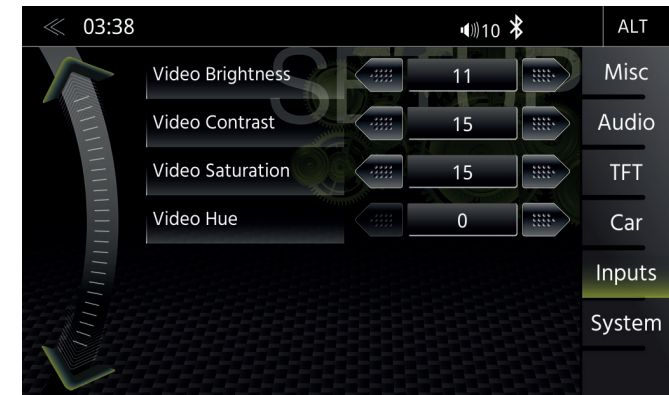

In the Input Setup menu, you can adjust the image settings of the connected video sources, such as Reverse Cameras. Contrast, brightness, color saturation and hue can be adjusted.

Function	Icon	Operation
Inputs		Tap to adjust image setup configuration of connected external video sources (e.g. rear view camera., etc.)
Brightness		0 ~ 24
Contrast		0 ~ 24
Saturation		0 ~ 24
Hue		0 ~ 24

SYSTEM SETUP

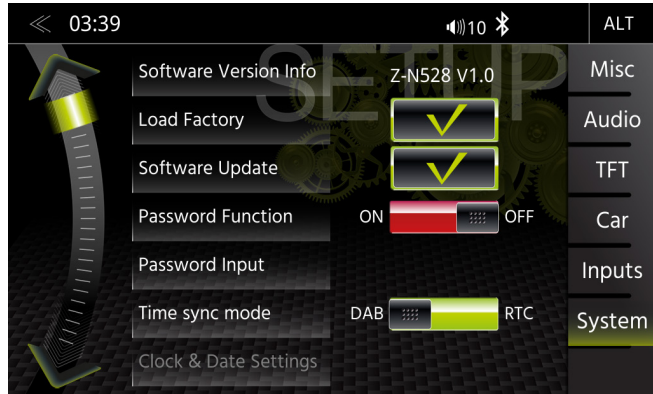

In the System Setup menu page, you can make various system settings, such as: Adjust the Clock Time, Load Factory settings, Initiate Software Updates or set a Password.

Function	Icon	Operation
System		Tap to access various system settings
SW Versions Info		Tap to access detailed software version information
Load Factory		Tap and confirm to reset the ZENEC system to factory default
Clock Time Setup		Tap to adjust clock time
Software Update		Tap and confirm to initiate a software update. www.zenec.com → Support → Softwareupdates
Password Function		OFF = password protection disabled ON = password protection enabled
Password		Tap and confirm to store a password

CLOCK TIME





In the System Setup menu page under Clock Time, you can set the format, change the displayed time and select the time sync source (system time or DAB) for the time display.

Function	Icon	Operation
Clock Time Sync. Mode		Tap to change the clock time sync. mode
		DAB Sync automatic synchronisation by DAB (Manual adjustments such as clock time and time zone not possible)
		RTC Sync automatic synchronisation by system RTC (Manual adjustments possible)
Date & Clock Time		Tap to change time and date (Year:Month:Day) if sync is "RTC Sync."
Clock Format		Tap to change the clock format

SOFTWARE VERSION



In the System Setup menu page under SW version, you will see the currently installed software versions with detailed version info for MCU, OS and AP, inclusive a simple Short Software Version.

Function	Icon	Operation
System		Tap to access this view
SW Version		Displays the current software version information

PASSWORD

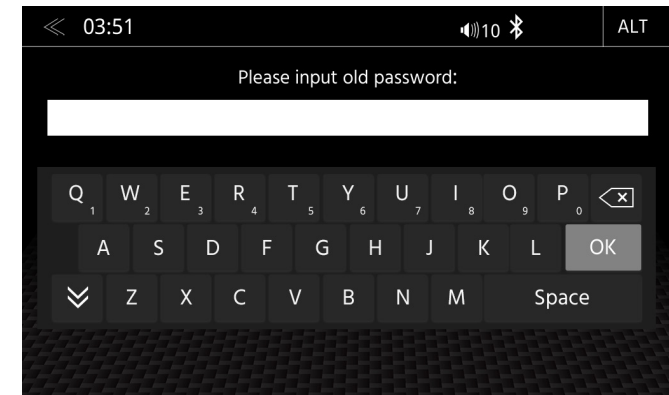

In the System Setup menu page under Password function, you can activate and deactivate the password protection.

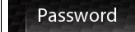
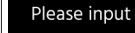
Function	Icon	Operation
Password Function		OFF = password protection disabled ON = password protection enabled
Password		Tap and confirm to store a password* Standard password "12345"
Input Keypad		Enter the desired password

⚠ CAUTION

* If you protect you ZENEC system with a Password make sure, you have access to this password anytime.
Lost or forgotten Passwords require the device to be uninstalled and sent in to ZENEC Service Centre. Device unlocking is not free of charge.

INSTALLATION NOTES

⚠ CAUTION

- The installation of the ZENEC system should be carried out by an authorized installer. Specific knowledge and tools are required to do the installation. Incorrect installation can cause damage to the vehicle and the ZENEC system.
- Correct functioning can only be guaranteed when you use the ZENEC original accessories included in the kit or those optionally available. The ZENEC system and the original accessories must under no circumstances be modified or altered in any way. Inappropriate actions can cause damage to the vehicle and the ZENEC system.

i NOTE

- The ZENEC system is not compatible with vehicles, which are equipped with a hybrid or electro drive ex factory.
- The ZENEC Z-N528 is equipped with an integrated DAB+ receiver. To make use of this you will need a suitable DAB antenna (not included in kit) that must be connected to the ZENEC system.
- If the target vehicle is already equipped with an original DAB antenna, it is still possible to use it in combination with the ZENEC system.
- Software updates to the ZENEC system are installed with a USB memory device. Therefore when fitting the system make sure that the USB connection of the ZENEC system will still be accessible later (installation of USB extension cable or USB hub).
- If you have questions or problems relating to the ZENEC system, please contact the dealer from whom you purchased it.

REMOVAL WORK AND PREPARATION

i NOTE

1. Remove the ignition key and keep it outside the car until the installation is finished.
2. Please wait for ca. 10 minutes until the CAN bus system is completely shut down, before you start with the deinstallation of the original device.
3. Start with the deinstallation of the original device.
4. Please switch on the ignition only, when all work steps are done and the ZENEC system is completely mounted.

i NOTE

- Make sure that all connectors at the rear of the ZENEC system have sufficient room and are not bent.
- Connectors without a retaining mechanism must be additionally secured with insulating tape.

OVERVIEW INCLUDED ACCESSORIES

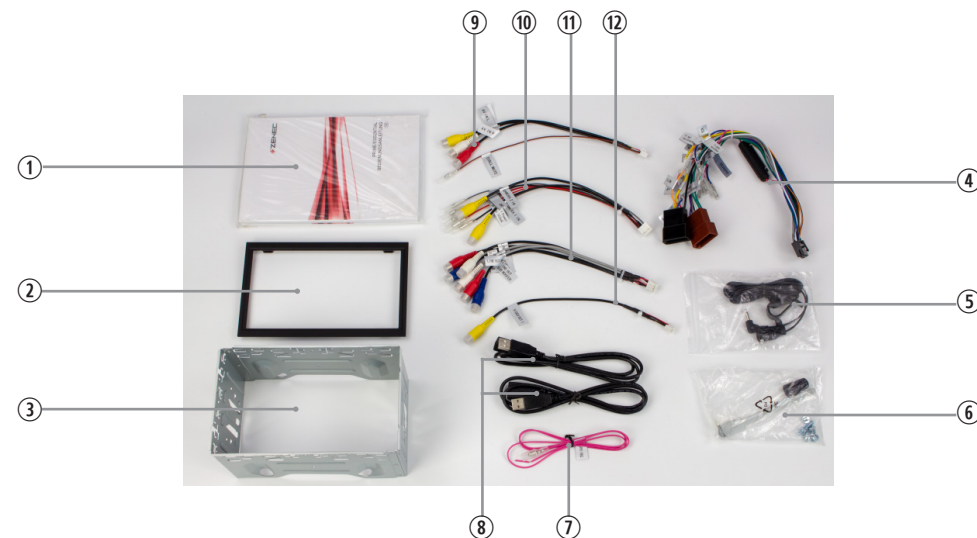

No.	Article	Qty
1	Main device user manual	1
2	2DIN trim frame	1
3	2DIN metal device mounting cage	1
4	ISO-DIN main harness	1
5	Bluetooth microphone with mounting clip	1
6	Factory radio removal tool	1
7	Parking break wire	1
8	USB extension cable	2
9	A/V IN / Video IN / eCall Mute	1
10	Camera 1 & 2 / Reverse Signal / Steering Wheel Control interface (IR-IN)	1
11	4.2 RCA preamp line out / Subwoofer	1
12	Video OUT	1

CONNECTION DIAGRAM Z-N528

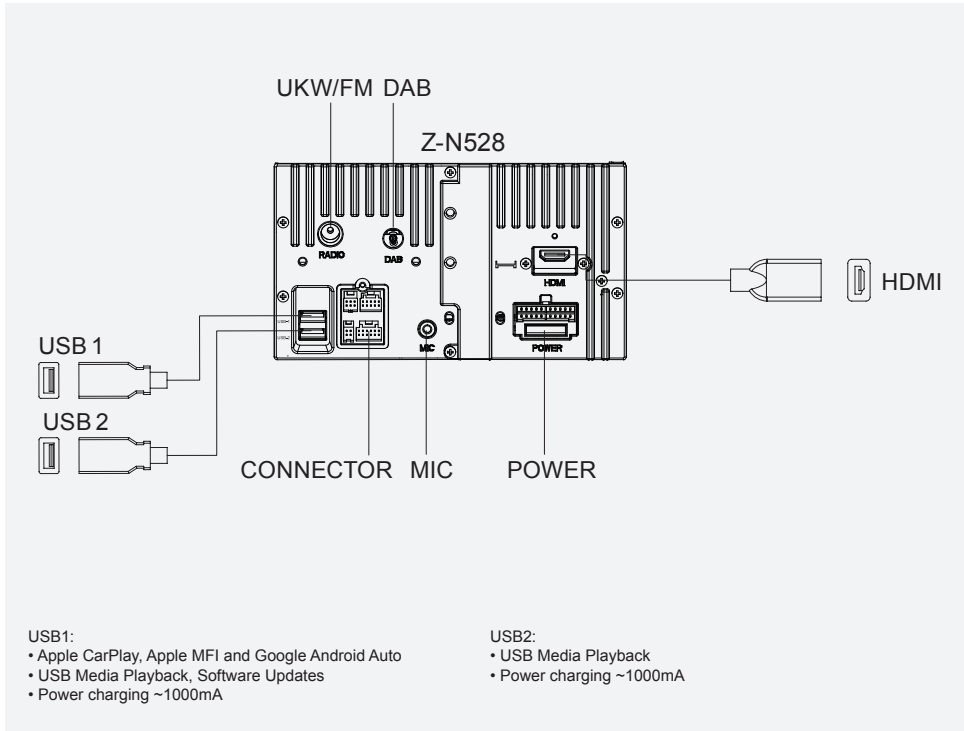

CONNECTION DIAGRAM Z-N528 (PAGE 2)

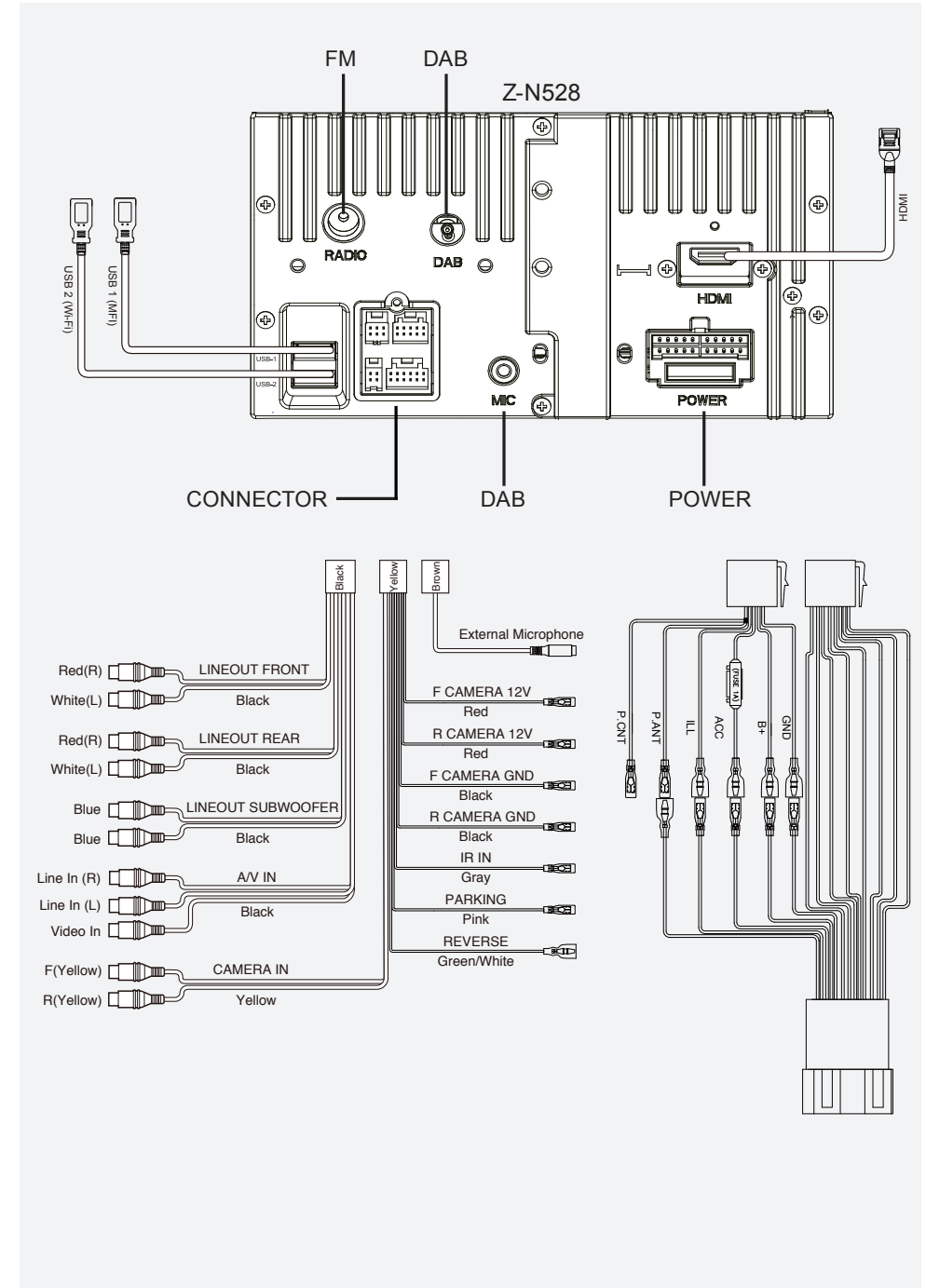

GENERAL

ABBREVIATIONS

Abbreviation	Description
A2DP	Manufacturer-independent Bluetooth® technology allowing audio signals to be transmitted (Advanced Audio Distribution Profile)
AF	Alternative frequency
CAN-Bus	The CAN bus (Controller Area Network) is a serial bus system for the communication of control units in a vehicle
CP	Apple CarPlay
DAB / DAB+	Transmission standard for terrestrial reception of digital radio (Digital Audio Broadcasting)
DSP	The digital signal processor is used for the processing of digital signals (e.g. audio or video signals)
EQ	Equalizer
FAT32	Formatting format for digital media (File allocation table 32-bit)
UKW/FM	Transmission standard for terrestrial reception of very high frequency analog radio (UKW)
GAA / AAP	Google Android Auto
GPS	Global navigation satellite system for position fixing (Global Positioning System)
GSM	Global mobile radio network standard for fully digital mobile radio networks (Global System for Mobile Communications)
ID3-Tag	ID3 tags mean meta data, which could be included together with the MP3 format.
microSD	Compact flash memory
REG	Regional station
SSP	Secure Simple Pairing (for Bluetooth devices)
TA	Traffic Announcement (RDS service)
USB	A USB connection is a serial bus system for connecting a device to other devices (Universal Serial Bus).

STATUTORY RIGHTS AND WARRANTY

What products are covered by ZENEC's limited Warranty?

The limited Warranty (the "Warranty") applies to ZENEC products purchased from an authorized dealer by end customers in the European Economic Area or Switzerland ("Territorial Scope").

What is the validity period of ZENEC's Warranty?

Under this Warranty, ZENEC warrants, for a period of 2 years, that the product is free from defects in material and/or workmanship at the time of the original purchase. This 2-year period commences on the date of the original purchase as per the original invoice or until receipt. If you have purchased the product as a consumer, and the defect is identified within the first six months after the original purchase (see above), we will assume that the defect already existed at the time of purchase.

Who can claim under the Warranty?

ZENEC grants the limited Warranty to natural persons only, who purchased the relevant product primarily for personal use.

What is covered by the Warranty?

ZENEC warrants that the product is free from defects in material and/or workmanship at the time of the original purchase. ZENEC does not, however, provide a warranty covering every defect and damage that may occur. It only covers the hardware components of the device, and in no event the software used with the device, regardless if this was provided by ZENEC or the third-party vendor. The Warranty therefore does not cover the following cases, in particular:

- normal wear and tear (such as to surfaces and protective coverings);
- superficial damage, such as scratches, dents, and damaged plastic, worn or mechanically defective connections;
- misuse, including any treatment resulting in physical or superficial damage, such as a cosmetic defect, to the product;
- damage caused by connecting or using the product for a purpose other than those specified, or a failure to observe the operating and/or installation instructions for the particular model;
- installation or use of the product contrary to the applicable technical standards, or the safety regulations in the country in which the product is installed or used;
- damage caused through an unauthorized attempted repair, or an attempted repair by someone other than a ZENEC authorized service partner;
- damage caused by modifications to the product not expressly authorized by the manufacturer;
- damage caused by malicious code ("Software Viruses") or by using software not supplied with the product or which was incorrectly installed;
- use of third party vendor software programs for editing, modifying, adapting, or extending ZENEC's authorized software components as are run on the product;
- use of third-party vendor firmware/operating system software
- damage caused by liquids or chemicals of whatever type, and/or excessive temperatures, moisture, or damp;
- accidents, drops or other such effects of extreme accelerating forces;
- damage caused by lightning strikes, electrostatic charge, incorrect operating voltage, water, fire, force majeure, inadequate ventilation for other reasons for which ZENEC is not responsible;
- damage caused by using the device outside of the defined specifications;
- damage caused by using the product with other systems or devices, which are not designed to be used with this product;
- adjustments or modifications without ZENEC's prior written approval, including product upgrades extending beyond the specifications or characteristics described in the operating manual;
- modifications of the product for the purpose of adapting it to national or local technical norms or safety standards of countries for which the product was not expressly designed or manufactured;
- using service or spare parts not produced or distributed by ZENEC;
- using the product in connection with accessories not approved for use with this product;

ZENEC, moreover, does not warrant (expressly, implicitly, statutorily, or otherwise) the quality, performance, reliability or suitability of the product for a particular purpose except as described, nor the software/firmware installed on the device ex works.

No warranty service will be provided, moreover, if the model number/serial number/UUID/product number on the product is changed, erased, made illegible or removed. The same applies if the receipt or invoice is incomplete and/or illegible when presented.

Is ZENEC liable for other defects or damage?

ZENEC will repair or replace products, only if they are covered by the terms of this Warranty. ZENEC is not liable for any material or intangible loss or damage such as the price paid for the product, loss of profits, revenue, data, or relating to the enjoyment of the product or components associated with it, arising directly or indirectly under this Warranty or otherwise in relation to products or services. This likewise applies to loss or damage relating to the impairment or operational failure of the product, or devices associated with it, caused by defects or the non-availability of the product during the time it is with ZENEC or ZENEC's service partner, as well as to periods of downtime and business interruptions. In addition, ZENEC does not accept any liability for shipment-related risks - such as the loss or destruction of the product - in connection with the fulfilment of the Warranty.

This disclaimer applies to losses of damage irrespective of the legal basis, especially on the grounds of negligence, other wrongful conduct (torts), breach of contract, express or implied guarantees, and strict liability (even if ZENEC or its service partner has been advised of the possibility of such damage occurring).

If these disclaimers are prohibited or limited under the applicable law, ZENEC will limit its Warranty and liability to the extent permissible under the applicable regulations. For example, some national laws prohibit the exclusion or limiting of damages payable in connection with negligence, gross negligence, willful wrongdoing, deceitful conduct, and other such acts. For the duration of this Warranty, all liability that cannot be excluded completely will be limited to the extent permissible under the applicable law. Liability under this Warranty is limited to the price paid for the product. If the applicable law only permits higher limits on any liability, this higher limitation will apply.

How do I exercise my Warranty rights?

If you want to exercise your entitlements under this Warranty, please contact the authorized dealer where the product was purchased, and present it with the original copy of the till receipt or invoice. Do not return any products to ZENEC directly, otherwise our Warranty obligations cannot be fulfilled. You will find the name of the relevant dealer or reseller on your proof of purchase.

Defective devices sent by the authorized dealer to the service center, must also be accompanied by any accessories with a logical connection to the observed fault. This means, for example, the navigation package on an SD or microSD card supplied or purchased with the device, if problems or functional errors were observed in connection with the navigation function.

How will ZENEC fulfil its Warranty?

ZENEC or its service partner will choose to either repair or replace the product or its defective parts covered by the Warranty, and assume the costs of material and labor in doing so.

Repairs under the Warranty must be carried out by ZENEC or its authorized service partner. Products that are repaired or replaced may contain new and/or refurbished components and devices. Components that are swapped out will become the property of ZENEC.

Will I incur any costs in connection with the Warranty service?

ZENEC assumes the costs of material and labor in connection with its Warranty service. The Warranty holder is responsible for the costs of shipment and bears the risks connected with the shipment (see above). If the product is found to be operating faultlessly, or there is no warranty entitlement because the warrant period has expired or for any other reason, ZENEC or its authorized service partner will be entitled to charge a flat-rate investigation fee of €30.00.

Do this Warranty affect my statutory or contractual rights?

This Warranty is made voluntarily by ZENEC, and it will, in any case, extend your statutory rights. As a consumer, you remain fully entitled to your statutory rights, such as the statutory guarantee. This Warranty also has no effect whatsoever on your contractual rights against the reseller. You may continue to exercise these rights in full.

EU Legal Representative: ACR S & V GmbH · Industriestraße 35 · D-79787 Lauchringen · Germany
ZENEC by ACR AG · Bohrturmweg 1 · CH-5330 Bad Zurzach · Switzerland

www.zenec.com

Hereby, ACR Brändli + Vögeli AG declares that the type of radio equipment ZENEC Z-N528 complies with the 2014/53/EU Directive. The full text of the EU Declaration of Conformity is available at the following Internet address: <http://www.zenec.com> (see link "Product Conformity Documents" in the footer area of the page).

 10R-05 16981





© Copyright 2020

RevC / copy deadline: Q3-2020

English

Manufacturer: ACR AG · Bohrturmweg 1 · CH-5330 Bad Zurzach · Switzerland

EU Legal Representative: ACR S & V GmbH · Industriestraße 35 · D-79787 Lauchringen · Germany